

numed technologies  
the utmost degree of confidence in quality & service

## “numed” orthopeadics

Discover “numed” make – A absolute Prerequisite  
key for quality of its  
range of Surgical Instruments



“numed” Instruments for General Surgery, surgical Oncology, Micro  
Vascular, Plastic Surgery, Urology, Gynaecology



A-227, II FLOOR, OKHLA INDUSTRIAL AREA,  
PHASE-I, OKHLA, NEW DELHI – 20.  
PH. 011- 40506330, FAX. 40506331  
Mob.- 09818274945, 09910222245  
EMAIL : [numedtech@gmail.com](mailto:numedtech@gmail.com)  
Web.: [www.numed.co.in](http://www.numed.co.in)





## Total Quality Assurance

As a medical professional, you want to ensure the utmost quality and integrity of your surgical instruments at all times. You also want to protect your considerable investment in these high-grade medical devices.

### USP OF “nu med” Surgical Instruments

#### Steel Components:

We are currently using AISI 410, AISI 420, and 18/8 type of stainless steel and according to the items specifications.

#### Anti Rust Protection

We have accurate furnaces to obtain hardness of C-40 to C-45 on Forceps and between C-50 TO C-55 on Scissors and Sharpened Instruments.

#### Instruments Quality Warranty:

We offers 2 year's quality warranty against rust, manufacturing defect. Free replacement is offered in case of any manufacturing defect, though there is a minor chance of such happening.

#### Specialty Products:

“nu med” special products are carefully designed according to end user application to enrich surgical techniques.



Bone Surgery  
Gerster-Lowman  
Bone Holding Clamp



11-200-18  
18cm / 7"

Other available Sizes



11-200-20  
20cm / 8"



11-200-22  
22cm / 8 3/4"



Bone Surgery  
11-205-15  
Gerster Traction Bar  
15cm / 6"



Bone Surgery  
11-300-18  
Flat Nose Plier  
18.5 cm / 7 1/4"  
parallel grip  
Stainless Steel



Bone Surgery  
11-310-15  
Combi-Flat Nose Plier  
15 cm / 6" for bending and cutting

Also Available



11-310-18a



11-310-18b



Bone Surgery  
11-310-18  
Flat Nose Plier  
18 cm / 7" Parallel Grip



Bone Surgery  
11-315-14  
Flat Nose Plier  
13.5 cm / 5 1/4"



Dressings  
10-250-24  
Bruns Plaster Scissors  
24 cm / 9 1/2"  
One Serrated Cutting Edge



Dressings  
10-275-23  
Stille-Martin Plaster Shears  
23 cm / 9"



Dressings  
10-275-27  
Stille-Martin Plaster Shears  
27 cm / 10.5"



Dressings  
10-275-38  
Stille-Martin Plaster Shears  
38 cm / 15"



Dressings  
10-320-20  
Hopkins Plaster Knife  
20 cm / 8"  
with Wooden Handle



Dressings  
10-350-18  
Esmarch Plaster Knife  
18 cm / 7"



Dressings  
10-355-18  
Reiner Plaster Knife  
18 cm / 7"



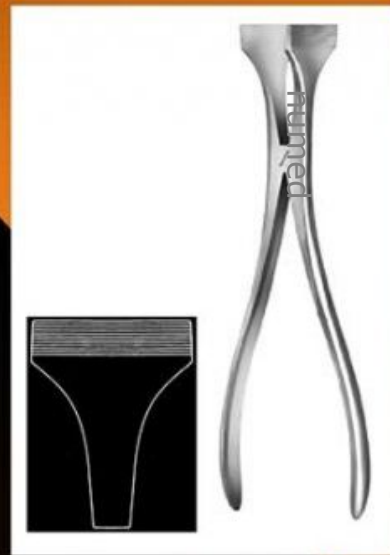
Dressings  
10-360-21  
Martin Plaster Knife  
21 cm / 8 1/4"  
with wooden handle



Dressings  
10-395-14  
Engel Plaster Saw  
15.5 cm / 6"



Dressings  
10-430-48  
Hermann Plaster Spreader  
48 cm / 19"  
Heavy Pattern



Dressings  
10-433-28  
Hennig Plaster Spreader  
28 cm / 11"



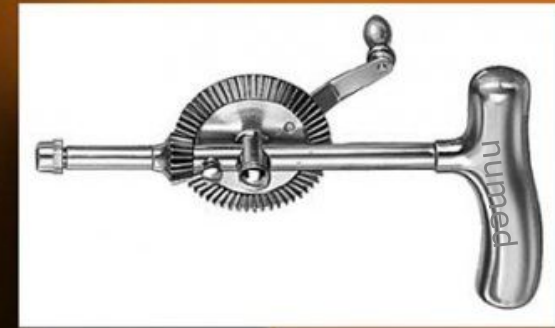
Dressings  
10-435-23  
Quattro Plaster Spreader  
23 cm / 9"



Dressings  
10-455-18  
Wolff Plaster Breaker  
18 cm / 7"



Dressings  
10-460-26  
Wolff Plaster Breaker  
26.5 cm / 10 1/2"



Bone Surgery  
11-138-01  
Stille Hand Drill  
20.5 cm / 8"  
with 9 twist drills (See Art # 11.138.02)

Complete with Hand Drill art # 11-138-01

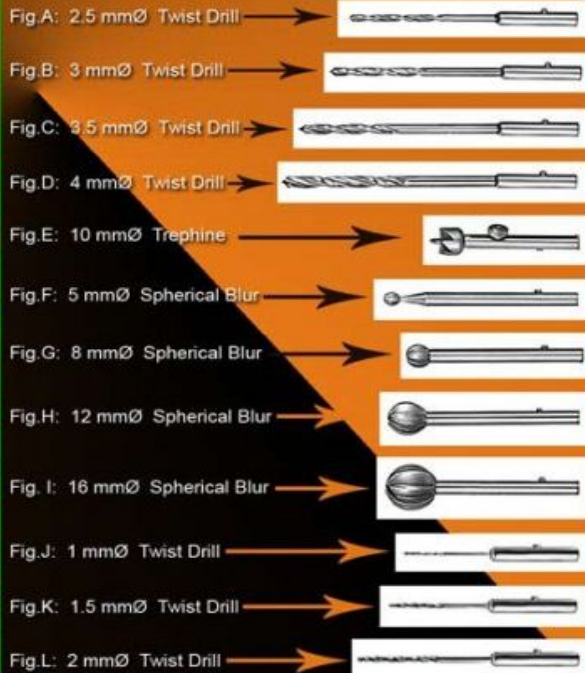


Fig.A: 2.5 mmØ Twist Drill  
Fig.B: 3 mmØ Twist Drill  
Fig.C: 3.5 mmØ Twist Drill  
Fig.D: 4 mmØ Twist Drill  
Fig.E: 10 mmØ Trephine  
Fig.F: 5 mmØ Spherical Burr  
Fig.G: 8 mmØ Spherical Burr  
Fig.H: 12 mmØ Spherical Burr  
Fig.I: 16 mmØ Spherical Burr  
Fig.J: 1 mmØ Twist Drill  
Fig.K: 1.5 mmØ Twist Drill  
Fig.L: 2 mmØ Twist Drill



Conical Burr Fig.1: 9 mmØ



Conical Burr Fig.2: 14 mmØ



Spherical Burr Fig.3: 16 mmØ



Spherical Burr Fig.4: 22 mmØ



Extension Piece Fig.9

Bone Surgery  
11-145-00  
Hudson Hand Drill  
28 cm / 11"

complete with burs Fig #. 1 - 4 and extension piece # 9.  
(pls see art # 11-145-01 for more acc)



Flat Trephine Fig.5: 14 mmØ



Twist Drill Fig.6



Burr Fig.7



Burr Fig.8

HUDSON  
( To be used with art # 11-145-00 Hand Drill)



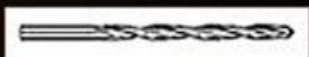
Bone Surgery  
11-150-00  
Moore Hand Drill  
complete with a set of 3  
twist drills



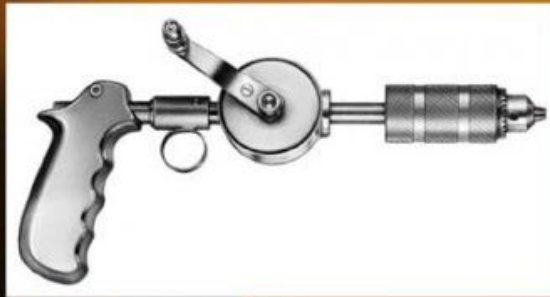
Twist Drill 70 X 3.2mm



Twist Drill 70 X 3.2mm



Twist Drill 90 X 3.2mm



Bone Surgery  
11-152-00  
Martin Hand Drill  
with Chuck & Wrench



11-152-01 Chuck borchardt shaft  
max opening 6,35



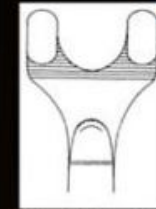
11-152-02 Wrench



Bone Surgery  
Gerster-Lowman  
Bone Holding Clamp

11-200-18  
18cm / 7"

Other available Sizes



11-200-20  
20cm / 8"



11-200-22  
22cm / 8 3/4"



Bone Surgery  
11-205-15  
Gerster Traction Bar  
15cm / 6"



Bone Surgery  
11-300-18  
Flat Nose Plier  
18.5 cm / 7 1/4"  
parallel grip  
Stainless Steel



Bone Surgery  
11-305-20  
Vise Grip  
20.5 cm / 8"  
Stainless Steel



Bone Surgery  
11-310-15  
Combi-Flat Nose Plier  
15 cm / 6" for bending and cutting

Also Available



11-310-18a



11-310-18b



Bone Surgery  
11-310-18  
Flat Nose Plier  
18 cm / 7" Parallel Grip



Bone Surgery  
11-315-14  
Flat Nose Plier  
13.5 cm / 5 1/4"



Bone Surgery  
11-315-18  
Round / Flat Nose Plier  
18 cm / 7"



Bone Surgery  
11-317-16  
Hackstock Flat Nose Plier  
with longitudinal groove  
16cm / 6 1/4"



Bone Surgery  
11-318-17  
Flat Nose Plier  
17.5 cm / 7"





Bone Surgery  
11-318-17B  
Flat Nose Plier  
17 cm / 6 3/4"  
with crosswise groove



Bone Surgery  
11-318-19  
Flat Nose Plier, pointed  
19.5 cm / 7 3/4"



Bone Surgery  
11-320-18  
Wire Cutting Pliers  
18.5 cm / 7 1/4"  
For soft wires up to 2.4mm Ø  
For hard wires up to 1.8mm Ø



Bone Surgery  
11-322-16  
Martin "Diamant"  
Wire Cutter, front action  
16 cm / 6 1/4"  
For soft wires up to 2.2mm Ø  
For hard wires up to 2.0mm Ø

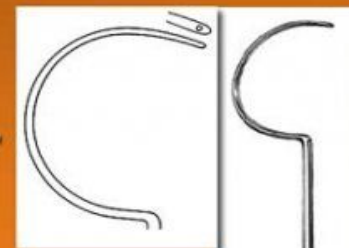
Bone Surgery  
11-330-02 (A-K)  
Bone Wire soft, coil of 10 m

- A: 0,2 mm Ø
- B: 0,3 mm Ø
- C: 0,4 mm Ø
- D: 0,5 mm Ø
- E: 0,6 mm Ø
- F: 0,7 mm Ø
- G: 0,8 mm Ø
- H: 0,9 mm Ø
- I: 1,0 mm Ø
- J: 1,2 mm Ø
- K: 1,5 mm Ø

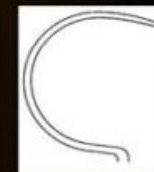


Please add alphabetic #s with 11-330-02  
when placing order

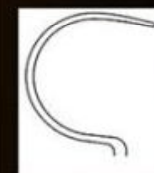
Bone Surgery  
11-335-00  
Demel  
Wire Guide  
31 cm / 12 1/4"



Other Sizes:



29 cm / 11 1/2"



28 cm / 11"



Bone Surgery  
11-340-21  
Loute Wire Tightener  
21 cm / 8 1/4"



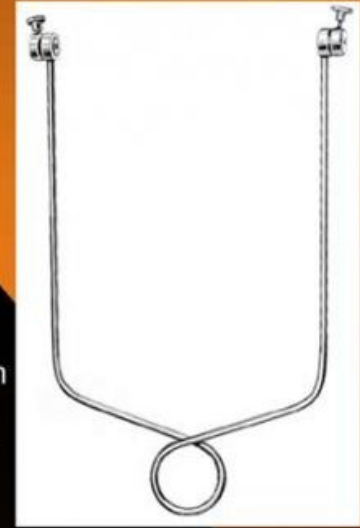
Bone Surgery  
11-360-00  
Steinmann Extension Pin  
14 cm / 5 1/2" with trocar point

Other Measurements

A: 16 cm / 6 1/4"  
B: 18 cm / 7"  
C: 20 cm / 8"

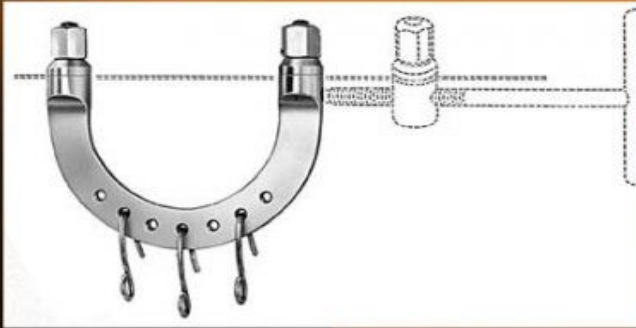


Bone Surgery  
11-365-00  
Böhler Extension  
Bow  
for femur & knee  
8" x 6"

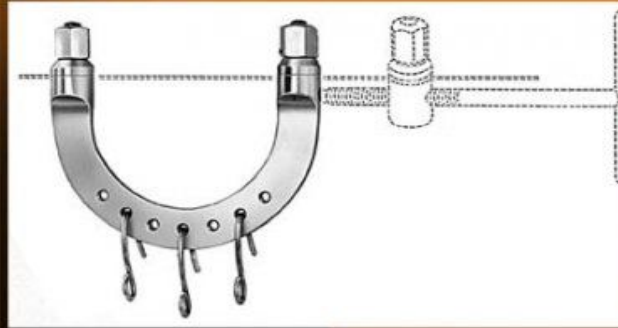


Other Measurements

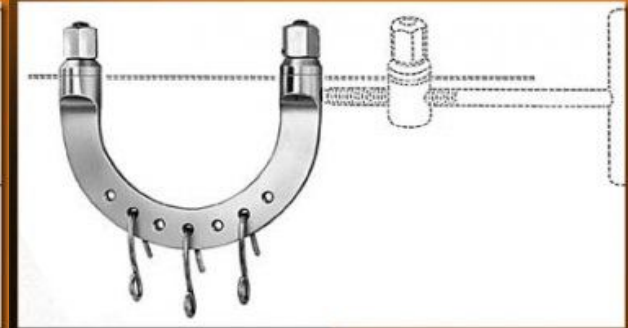
A: for arm 6 1/4" x 4 1/2"  
B: for femur and knee 8 1/4" x 4 1/2"



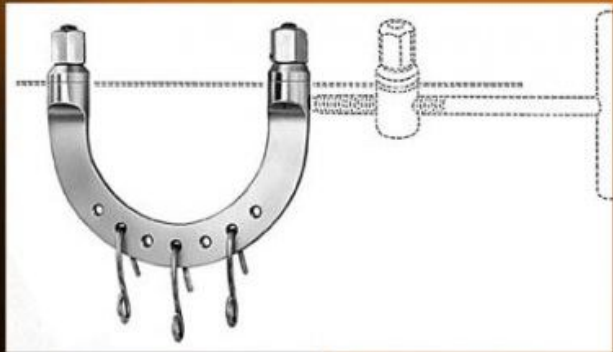
Bone Surgery  
11-380-01  
Kirschner Extension Bow  
with 3 traction hooks  
for children  
Inner width 95X70mm



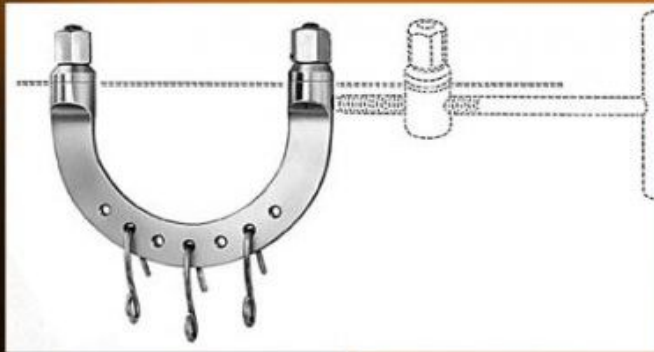
Bone Surgery  
11-380-02  
Kirschner Extension Bow  
with 3 traction hooks  
for wrist and ankle  
Inner width 105X105mm



Bone Surgery  
11-380-03  
Kirschner Extension Bow  
with 3 traction hooks  
for elbow  
Inner width 120X120mm



Bone Surgery  
11-380-04  
Kirschner Extension Bow  
with 3 traction hooks  
for knee  
Inner width 155X155mm



Bone Surgery  
11-380-05  
Kirschner Extension Bow  
with 3 traction hooks  
for femur  
Inner width 200X155mm



Bone Surgery  
11-385-18  
Kirschner Extension Bow  
18.5 cm / 7 1/4"  
with 3 traction hooks  
small pattern



Bone Surgery  
11-385-26  
Kirschner Extension Bow  
26.5 cm / 10 1/2"  
with 3 traction hooks  
Large pattern



Bone Surgery  
11-387-18  
Wire Strainer  
18.5 cm / 7 1/4"



Bone Surgery  
11-390-20  
Wrench  
20 cm / 8"



Bone Surgery  
11-392-07  
Extension Bow  
7" X 4"



Bone Surgery  
11-392-10  
Extension Bow  
10 1/2" X 6 1/4"



Fig A:



Fig B:



Fig C:

Bone Surgery  
11-400-00  
Extension Sleeve  
wire mesh, autoclavable  
Fig A: Small  
Fig B: Medium  
Fig C: Large



Bone Surgery  
11-405-00  
Fixation Discs  
for wire drills, pair



Bone Surgery  
11-407-00  
Traction Hook for Extension Bows



Bone Surgery  
11-410-16  
Bunnell Hand Drill 16cm,  
Longitudinally bored with three-jaw-chuck  
light metal housing  
opening up to 4mmØ  
11-410-16a spare Key for three jaw-chuck



Bone Surgery  
11-410-17  
Bunnell Type Hand Drill 16cm,  
Twin Shade Powder Coated  
Longitudinally bored with three-jaw-chuck  
light metal housing opening up to 4mmØ



Bone Surgery  
11-415-00  
Ralk Hand Drill  
Hand Drill light metal housing  
and literally angled handle with three-jaw-  
chuck and key, opening up to 6,35mmØ



Bone Surgery  
11-420-14  
Vickers Easidriver  
14 cm / 5 1/2"



without "T" handle



Bone Surgery  
11-425-00  
Handle with chuck  
T-Shaped  
Stainless Steel or  
Chrome Plated

Bone Surgery  
11-426-00  
14cm / 5 1/2"  
Handle with chuck  
Longitudinally bored  
Accommodating up to 3,95mm



Bone Surgery  
11-430-00  
KirschnerWire Drill trocar point  
flat end



Bone Surgery  
11-425-01  
Key  
Stainless Steel or  
Chrome Plated



Bone Surgery  
11-426-01  
Key



Available sizes  
Length

|      | 6cm | 10cm | 12cm | 14cm | 16cm | 31cm |
|------|-----|------|------|------|------|------|
| mm Ø | 0,6 |      |      |      |      |      |
|      | 0,8 |      |      |      |      |      |
|      | 1,0 | 1,0  | 1,0  | 1,0  | 1,0  | 1,0  |
|      | 1,2 | 1,2  | 1,2  | 1,2  | 1,2  | 1,2  |
|      | 1,4 | 1,4  | 1,4  | 1,4  | 1,4  | 1,4  |
|      | 1,5 | 1,5  | 1,5  | 1,5  | 1,5  | 1,5  |
|      | 1,6 | 1,6  | 1,6  | 1,6  | 1,6  | 1,6  |
|      | 1,8 | 1,8  | 1,8  | 1,8  | 1,8  | 1,8  |
|      | 2,0 | 2,0  | 2,0  | 2,0  | 2,0  | 2,0  |
|      | 2,2 | 2,2  | 2,2  | 2,2  | 2,2  | 2,2  |
|      |     |      |      | 2,5  | 2,5  |      |

Please mention both sizes when placing order

Bone Surgery  
11-432-00  
Kirschner Wire Drill trocar point  
round end



Available sizes  
Length

6cm 10cm 12cm 14cm 16cm 31cm

|      |     |     |     |     |     |     |
|------|-----|-----|-----|-----|-----|-----|
| mm Ø | 1,0 | 1,0 | 1,0 | 1,0 | 1,0 | 1,0 |
|      | 1,2 | 1,2 | 1,2 | 1,2 | 1,2 | 1,2 |
|      | 1,4 | 1,4 | 1,4 | 1,4 | 1,4 | 1,4 |
|      | 1,5 | 1,5 | 1,5 | 1,5 | 1,5 | 1,5 |
|      | 1,6 | 1,6 | 1,6 | 1,6 | 1,6 | 1,6 |
|      | 1,8 | 1,8 | 1,8 | 1,8 | 1,8 | 1,8 |
|      | 2,0 | 2,0 | 2,0 | 2,0 | 2,0 | 2,0 |
| 2,2  | 2,2 | 2,2 | 2,2 | 2,2 | 2,2 |     |
|      |     |     |     | 2,5 | 2,5 |     |

Please mention both sizes when placing order

Bone Surgery  
11-435-00  
Kirschner Wire Drill lancet point  
flat end



Available sizes

Length  
31cm

|      |     |
|------|-----|
| mm Ø | 1,0 |
|      | 1,2 |
|      | 1,5 |
|      | 1,6 |
|      | 1,8 |
|      | 2,0 |
|      | 2,2 |
| 2,5  |     |

Please mention both sizes when placing order



Bone Surgery  
11-450-00  
Hand Drill

All Covered  
Black or White Powder Coated.  
Drills Holder at Bottom.



Bone Surgery  
11-455-01

Box for  
Hand drills with art #s: 11-450-00 and  
11-455-00  
Outside Artificial leather and inside Jumbo  
foam, Velcro topping.



Bone Surgery  
12-100-7  
Virchow Skull Breaker  
7.5 cm / 3"



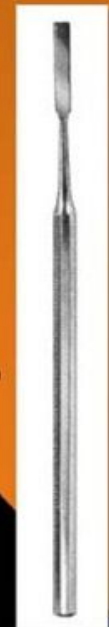
Fig A: 2mm



Fig B: 3mm

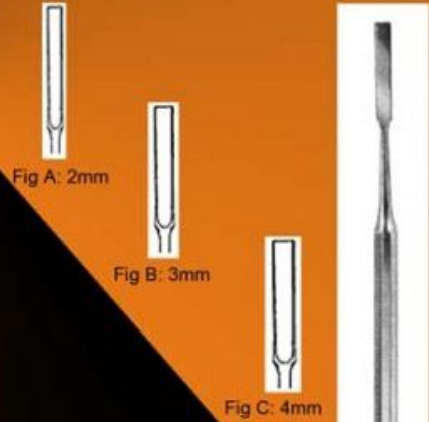


Fig C: 4mm



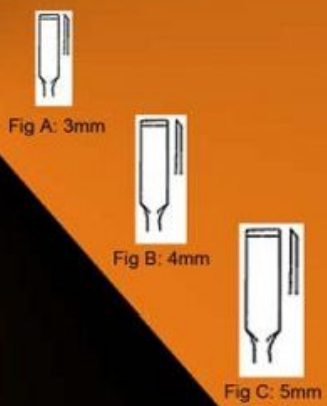
Bone Surgery  
12-110-16  
Buckley Chisel  
16 cm / 6 1/4"  
octagonal handle  
Fig A: 2mm  
Fig B: 3mm  
Fig C: 4mm

pls mention correspondent sizes when placing order



Bone Surgery  
12-110-17  
Buckley Gouge  
16 cm / 6 1/4"  
octagonal handle  
Fig A: 2mm  
Fig B: 3mm  
Fig C: 4mm

pls mention correspondent sizes when placing order



Bone Surgery  
12-112-21  
Stout Bone Chisel  
21 cm / 8 1/4"  
octagonal handle  
Fig A: 3mm  
Fig B: 4mm  
Fig C: 5mm

pls mention correspondent sizes when placing order



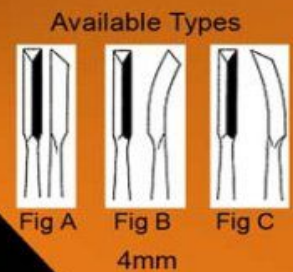
Bone Surgery  
12-115-18  
Bone Chisel  
18 cm / 7"  
&  
17 cm / 6 3/4"  
Round handle



Bone Surgery  
12-115-19  
Bone Chisel  
17 cm / 6 3/4"  
Round handle  
4mm



Bone Surgery  
12-116-18  
Bone Chisel  
18 cm / 7"  
octagonal handle  
4mm



Bone Surgery  
12-118-17  
Gardner  
Bone Chisel  
17 cm / 6 3/4"  
4mm

pls mention correspondent sizes when placing order

Available Types



Fig A:  
3mm



Fig B:  
5mm



Bone Surgery  
12-122-16  
Snyder-O.S.U  
Bone Chisel  
16.5 cm / 6 1/2"  
3 mm / 5 mm

pls mention correspondent sizes when placing order



7mm



Bone Surgery  
12-124-17  
O.S.U.  
Bone Chisel  
17 cm / 6 3/4"  
7mm



9mm



Bone Surgery  
12-126-17  
O.S.U.  
Bone Chisel  
17 cm / 6 3/4"  
9mm

Available sizes



Fig:A  
8mm



Fig:B  
10mm



Fig:C  
12mm



Fig:D  
14mm



Fig:E  
16mm



Side View



Bone Surgery  
12-135-13  
Osteotome  
13.5 cm / 5 1/4"

pls mention correspondent sizes when placing order

Available sizes



Fig:A  
8mm



Fig:B  
10mm



Fig:C  
12mm



Fig:D  
14mm



Fig:E  
16mm



Side View



Bone Surgery  
12-137-13  
Chisel  
13.5 cm / 5 1/4"

pls mention correspondent sizes when placing order

Available sizes



Fig:A  
8mm



Fig:B  
10mm



Fig:C  
12mm



Fig:D  
14mm



Fig:E  
16mm



Side View



Bone Surgery  
12-140-13  
Gouge  
13.5 cm / 5 1/4"

pls mention correspondent sizes when placing order



Available sizes



Side View



Bone Surgery  
12-145-13  
Partsch  
Chisel  
13.5 cm / 5 1/4" &  
17cm / 6 3/4"

pls mention correspondent sizes when placing order

Available sizes



Side View



Bone Surgery  
12-147-13  
Partsch  
Gouge  
13.5 cm / 5 1/4" &  
17cm / 6 3/4"

pls mention correspondent sizes when placing order

Available sizes



Side View



Bone Surgery  
12-155-17  
Alexander Gouge  
17.5 cm / 7"

pls mention correspondent sizes when placing order

Available sizes



Side View



Bone Surgery  
12-160-20  
Stille Chisel  
20 cm / 8"

pls mention correspondent sizes when placing order

Available sizes



Side View



Bone Surgery  
12-162-20  
Stille Osteotome  
20 cm / 8"

pls mention correspondent sizes when placing order

Available sizes



Side View



Bone Surgery  
12-165-20  
Stille Gouge  
20 cm / 8"

pls mention correspondent sizes when placing order

Available RADIUS sizes  
r= 50mm / 60mm / 70mm



Bone Surgery  
12-170-13  
Gouge Blade  
13.5 cm / 5 1/4"  
interchangeable  
25mm

pls mention correspondent sizes when placing order

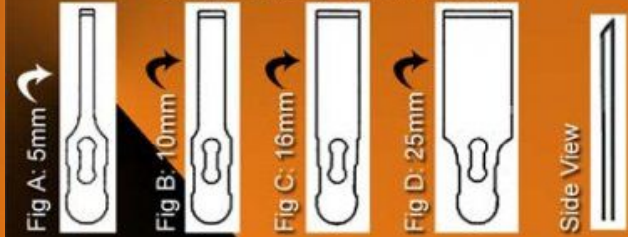
Bone Surgery  
12-172-18  
Chisel Handle  
18.5 cm / 7 1/4"

Handle, only  
Pls see art # 12-172-19 for chisel / osteotome  
blades (sizes)

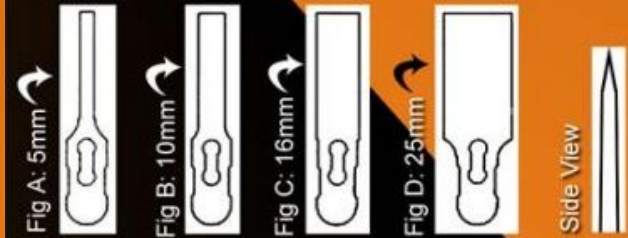
And see art # 12-172-20 for spare screw and key



Chisel Blades (8.5 cm / 3 1/4")

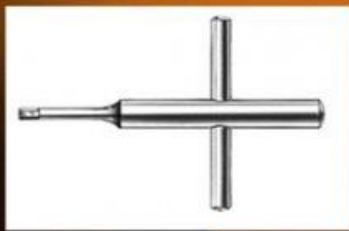


Osteotome Blades (8.5 cm / 3 1/4")



Bone Surgery  
12-172-19  
Chisel / Osteotome Blades

pls mention correspondent sizes when placing order



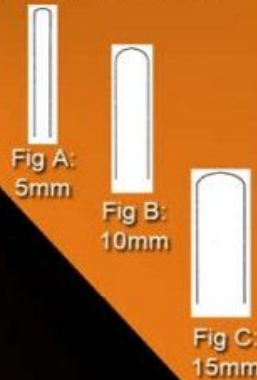
Key

Spare  
Screw



Bone Surgery  
12-172-20  
Spare screw / key for Chisel Handle  
key size 9 cm / 3 1/2"

Available sizes

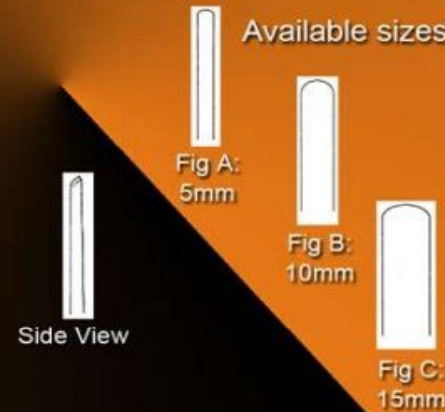


Bone Surgery  
12-174-25  
Lexer Spongiosa Gouge  
25 cm / 9 3/4"

pls mention required sizes when placing order



Available sizes



Bone Surgery  
12-175-25  
Lexer Spongiosa Gouge  
25 cm / 9 3/4"

pls mention required sizes when placing order



Available TIP sizes



- Fig A: 4mm
- Fig B: 6mm
- Fig C: 8mm
- Fig D: 10mm
- Fig E: 12mm



Bone Surgery  
12-178-18  
Lexer, Mini Osteotome  
18.5 cm / 7 1/4"

pls mention required sizes when placing order

Available TIP sizes

- Fig A: 4mm
- Fig B: 6mm
- Fig C: 8mm
- Fig D: 10mm
- Fig E: 12mm



Bone Surgery  
12-180-18  
Lexer, Mini Gouge  
18.5 cm / 7 1/4"

pls mention required sizes when placing order

Available TIP sizes

- Fig A: 7mm
- Fig B: 10mm
- Fig C: 15mm
- Fig D: 20mm
- Fig E: 25mm
- Fig F: 30mm



Bone Surgery  
12-182-22  
Lexer, Osteotome  
22 cm / 8 3/4"

pls mention required sizes when placing order

Available TIP sizes

- Fig A: 7mm
- Fig B: 10mm
- Fig C: 15mm
- Fig D: 20mm
- Fig E: 25mm
- Fig F: 30mm



Bone Surgery  
12-184-22  
Lexer, Gouge  
22 cm / 8 3/4"

pls mention required sizes when placing order

Available TIP sizes

- 2mm / 3mm / 4mm / 6mm / 8mm / 10mm / 12mm / 15mm



Bone Surgery  
12-186-12  
Lambotte, Mini Osteotome  
12.5 cm / 5"

pls mention required sizes when placing order

Available TIP sizes

- 3mm / 4mm / 6mm / 8mm / 10mm / 12mm / 15mm



Bone Surgery  
12-186-17  
Lambotte, Mini Osteotome  
17 cm / 6 3/4"

pls mention required sizes when placing order

Available TIP sizes



15mm / 20mm / 25mm /  
30mm / 38mm / 44mm / 50mm



Side View



Bone Surgery  
12-186-24  
Lambotte, Osteotome  
24 cm / 9 1/2"

pls mention required sizes when placing order

Available TIP sizes



15mm / 20mm / 25mm /  
30mm / 38mm / 44mm / 50mm



Side View  
Curved Tip



Bone Surgery  
12-188-24  
Lambotte, Osteotome  
24 cm / 9 1/2"

pls mention required sizes when placing order

Available TIP sizes



6mm / 9mm / 13mm /  
16mm / 19mm / 25mm / 32mm



Side View  
Pointed Tip



Bone Surgery  
12-195-20  
Smith-Petersen Osteotome  
20.5 cm / 8"

pls mention required sizes when placing order

Available TIP sizes



6mm / 9mm / 13mm /  
16mm / 19mm / 25mm / 32mm



Side View  
Curved Tip



Bone Surgery  
12-196-20  
Smith-Petersen Osteotome  
20.5 cm / 8"

pls mention required sizes when placing order

Available TIP sizes



9mm / 14mm / 19mm / 25mm



Bone Surgery  
12-198-20  
Smith-Petersen Gouge  
20.5 cm / 8"

pls mention required sizes when placing order

Available TIP sizes



9mm / 14mm / 19mm / 25mm



Side View  
Curved Type



Bone Surgery  
12-199-20  
Smith-Petersen Gouge  
20.5 cm / 8"

pls mention required sizes when placing order

Available TIP sizes



3mm / 5mm / 6mm / 8mm / 9mm



Side View



Bone Surgery  
12-205-17  
Hoke Osteotome  
17 cm / 6 3/4"

pls mention required sizes when placing order

Available TIP sizes



6mm / 13mm / 19mm / 25mm / 32mm



Side View



Bone Surgery  
12-210-24  
Hibbs Osteotome  
24.5 cm / 9 3/4"

pls mention required sizes when placing order

Available TIP sizes



6mm / 13mm / 19mm / 25mm / 32mm



Side View



Bone Surgery  
12-211-24  
Hibbs Chisel  
24.5 cm / 9 3/4"

pls mention required sizes when placing order

Available TIP sizes



6mm / 13mm / 19mm / 25mm / 32mm



Side View



Bone Surgery  
12-212-24  
Hibbs Gouge  
24.5 cm / 9 3/4"

pls mention required sizes when placing order



Bone Surgery  
12-220-30  
Putti Bone Rasp  
round / semi round  
30cm / 11 3/4"

Curved



Straight



Bone Surgery  
12-222-27  
Putti Bone Rasp  
curved / straight  
27cm / 10 3/4"

Enlarged View



Outer Ø 5.0mm  
Inner Ø 3.8mm



Bone Surgery  
12-230-22  
Champy-OSU  
Bone Biopsy Instrument  
22 cm / 8 3/4"

Consisting of trocar, a toothed trephine and a plunger for taking tibial and iliac bone grafts through a closed technique

Enlarged View



Outer Ø 8.0mm  
Inner Ø 7.0mm

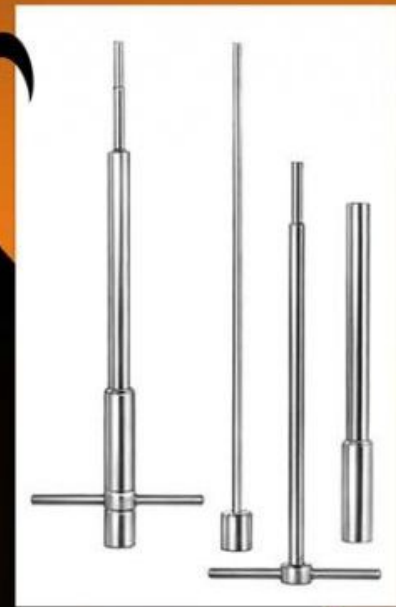


Bone Surgery  
12-231-22  
Champy  
Bone Biopsy Instrument  
22 cm / 8 3/4"

Enlarged View



Outer Ø 5.0mm  
Inner Ø 4.0mm



Bone Surgery  
12-232-22  
Champy  
Bone Biopsy Instrument  
22 cm / 8 3/4"



Enlarged View



Outer Ø 17mm  
Inner Ø 16mm

Bone Surgery  
12-234-22  
Champy Cancellous Bonegraft Mill  
22.5 cm / 8 3/4"

Bone Surgery  
12-240-18  
Vickers Spongiosa Gouge  
18 cm / 7"



Enlarged View



Tip Sizes available  
2mm Ø / 3mm Ø  
4mm Ø / 5mm Ø  
6mm Ø / 8mm Ø  
10mm Ø



Bone Surgery  
12-250-15  
Tamper  
15.5 cm / 6"

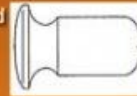
Enlarged View



Available Head Sizes  
& Approximate Weight  
26mm Ø / 300 gms  
28mm Ø / 340 gms  
30mm Ø / 400 gms  
pls mention required sizes when  
placing order

Bone Surgery  
12-260-24  
Williger Mallet  
24 cm / 9 1/2"  
lead filled

Enlarged View



Bone Surgery  
12-262-20 A/B/C  
Doyen Mallet

Available Length / Head Sizes  
& Approximate Weight

A:  
20.5cm / 8"  
25mm Ø / 120 gms

B:  
21cm / 8 1/4"  
30mm Ø / 180 gms

C:  
21.5cm / 8 1/2"  
35mm Ø / 260 gms

please mention required sizes when  
placing order

Bone Surgery  
12-264-20  
Collin Mallet  
20cm / 8"



Head size / approximate weight  
23mm Ø / 220 gms

Available in 2 sizes

Enlarged View



19mm Ø / 230 gms  
Head / Weight



25mm Ø / 260 gms  
Head / Weight



Bone Surgery  
12-270-19  
Lucae Mallet  
19.5cm / 7 3/4"

30mm Ø / 300 gms  
Head / Weight



Bone Surgery  
12-275-19  
Cottle Mallet  
Plane / convex  
19cm / 7 1/2"

20mm Ø / 140 gms  
Head / Weight



Bone Surgery  
12-276-16  
Williger Mallet  
16.4cm / 6 1/2"

30mm Ø / 510 gms  
Head / Weight



Bone Surgery  
12-278-26  
Mallet  
26 cm / 10 1/4"  
plastic handle

27mm Ø / 320 gms  
Head / Weight



Spare facing



Bone Surgery  
12-280-19  
Mead Mallet  
19 cm / 7 1/2"  
with interchangeable  
plastic disks

22mm Ø / 200 gms  
Head / Weight



Bone Surgery  
12-284-19  
Partsch Mallet  
19 cm / 7 1/2"  
with hollow handle

42mm Ø / 400 gms  
Head / Weight



Bone Surgery  
12-290-26  
Mallet  
26 cm / 10 1/4"  
made of plastic  
with lead filling

42mm Ø / 250 gms  
Head / Weight



Bone Surgery  
12-291-26  
Mallet  
26 cm / 10 1/4"  
made of plastic  
without lead filling

42mm Ø / 400 gms  
Head / Weight



Bone Surgery  
12-292-26  
Mallet  
26 cm / 10 1/4"  
made of plastic  
without lead filling



30mm Ø / 675 gms  
Head / Weight



Bone Surgery  
12-294-26  
Mallet  
26.5 cm / 10 1/2"  
plane (nylon) / convex  
(steel)  
plastic handle

42 / 30mm Ø / 530 gms  
Head / Weight



Bone Surgery  
12-296-26  
Mallet  
26 cm / 10 1/4"  
plastic handle

30mm Ø / 480 gms  
Head / Weight



Bone Surgery  
12-298-24  
Mallet  
24 cm / 9 1/2"  
plastic handle

37mm Ø / 370 gms  
Head / Weight



Spare facings (Pair)



Bone Surgery  
12-300-24  
Mallet  
24 cm / 9 1/2"  
Disks and handle of Plastic

30mm Ø / 125 gms  
Head / Weight



Bone Surgery  
12-302-22  
Mallet  
22 cm / 8 3/4"  
Made of Plastic

30mm Ø / 450 gms  
Head / Weight



Bone Surgery  
12-306-26  
Mallet  
26.5 cm / 10 1/2"  
plastic handle

50mm Ø / 900 gms  
Head / Weight



Bone Surgery  
12-307-26  
Mallet  
26.5 cm / 10 1/2"  
plastic handle

25mm Ø / 300 gms  
Head / Weight



Spare Facings



Bone Surgery  
12-310-19  
Vickers Mallet  
19 cm / 7 1/2"  
nylon disks  
plastic handle



Bone Surgery  
12-312-19  
Herbert Mallet  
19 cm / 7 1/2"  
for ulnar head  
prosthesis plastic handle

Available sizes



Sizes shown here may be slightly differ from the original one due to screen resolution.



Bone Surgery  
12-330-18  
Volkmann Bone Curette  
18.5 cm / 7 1/4"  
oval with plastic handle

pls mention required sizes when placing order

Available sizes



Sizes shown here may be slightly differ from the original one due to screen resolution.



Bone Surgery  
12-335-27  
Volkmann Bone Curette  
27.5 cm / 10 3/4"  
oval with plastic handle

pls mention required sizes when placing order

Available sizes



Sizes shown here may be slightly differ from the original one due to screen resolution.



Bone Surgery  
12-340-17  
Schede Bone Curette  
17 cm / 6 3/4"  
oval with hollow handle

pls mention required sizes when placing order

Available sizes



Sizes shown here may be slightly differ from the original one due to screen resolution.



Bone Surgery  
12-342-17  
Volkmann Bone Curette  
17 cm / 6 3/4"  
oval, with hollow handle

pls mention required sizes when placing order

Available sizes



Sizes shown here may be slightly differ from the original one due to screen resolution.



Bone Surgery  
12-344-17  
Bruns Bone Curette  
17 cm / 6 3/4"  
Round, with hollow handle

pls mention required sizes when placing order

Available sizes



Sizes shown here may be slightly differ from the original one due to screen resolution.



Bone Surgery  
12-346-17  
Spratt Bone Curette  
17 cm / 6 3/4"  
Oval, with hollow handle

pls mention required sizes when placing order

Available sizes



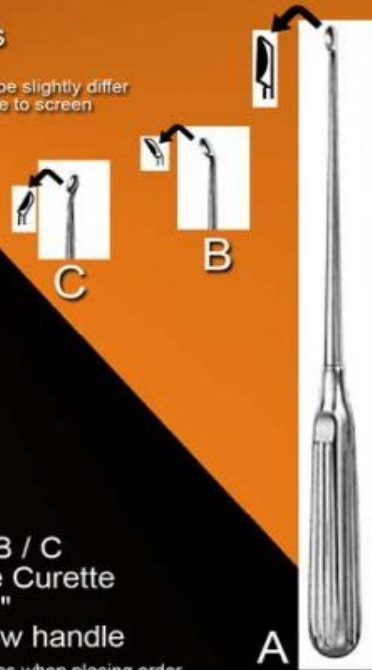
Sizes shown here may be slightly differ from the original one due to screen resolution.



Bone Surgery  
12-348-23  
Bruns Bone Curette  
23 cm / 9"  
oval, solid

pls mention required sizes when placing order

Available sizes



Sizes shown here may be slightly differ from the original one due to screen resolution.

Bone Surgery  
12-350-25 A / B / C  
Scoville Bone Curette  
25 cm / 9 3/4"  
oval, with hollow handle

pls mention required sizes when placing order

Available sizes



Sizes shown here may be slightly differ from the original one due to screen resolution.



Bone Surgery  
12-352-25  
Simon Bone Curette  
25 cm / 9 3/4"  
oval, with hollow handle

pls mention required sizes when placing order

Available sizes

Sizes shown here may be slightly differ from the original one due to screen resolution.

- 000
- 00
- 0
- 1
- 2
- 3
- 4



Bone Surgery  
12-340-17  
Schede Bone Curette  
17 cm / 6 3/4"  
oval with hollow handle

pls mention required sizes when placing order

Available sizes

Sizes shown here may be slightly differ from the original one due to screen resolution.

- 0000
- 000
- 00
- 0
- 1
- 2
- 3
- 4
- 5
- 6



Bone Surgery  
12-342-17  
Volkman Bone Curette  
17 cm / 6 3/4"  
oval, with hollow handle

pls mention required sizes when placing order

Available sizes

Sizes shown here may be slightly differ from the original one due to screen resolution.

- 00
- 0
- 1
- 2
- 3
- 4
- 5
- 6



Bone Surgery  
12-344-17  
Bruns Bone Curette  
17 cm / 6 3/4"  
Round, with hollow handle

pls mention required sizes when placing order

Available sizes

Sizes shown here may be slightly differ from the original one due to screen resolution.

- 0000
- 000
- 00
- 0
- 1
- 2
- 3
- 4
- 5



Bone Surgery  
12-346-17  
Spratt Bone Curette  
17 cm / 6 3/4"  
Oval, with hollow handle

pls mention required sizes when placing order

Available sizes

Sizes shown here may be slightly differ from the original one due to screen resolution.

- 000
- 00
- 0
- 1
- 2
- 3
- 4
- 5



Bone Surgery  
12-348-23  
Bruns Bone Curette  
23 cm / 9"  
oval, solid

pls mention required sizes when placing order

Available sizes

Sizes shown here may be slightly differ from the original one due to screen resolution.



Bone Surgery  
12-350-25 A / B / C  
Scoville Bone Curette  
25 cm / 9 3/4"  
oval, with hollow handle

pls mention required sizes when placing order

Available sizes

Sizes shown here may be slightly differ from the original one due to screen resolution.

- 1 
- 2 
- 3 
- 4 
- 5 
- 6 



Bone Surgery  
12-352-25  
Simon Bone Curette  
25 cm / 9 3/4"  
oval, with hollow handle

pls mention required sizes when placing order

Available sizes

Sizes shown here may be slightly differ from the original one due to screen resolution.

- 1 
- 2 
- 3 
- 4 
- 5 
- 6 



Bone Surgery  
12-354-16  
Modell USA Bone Curette  
16 cm / 6 1/4"  
Oval, with hollow handle

pls mention required sizes when placing order

Available sizes

Sizes shown here may be slightly differ from the original one due to screen resolution.

- 1 
- 2 
- 3 
- 4 
- 5 
- 6 



Bone Surgery  
12-356-15  
Modell USA Bone Curette  
15.5 cm / 6 "  
Oval, with hollow handle

pls mention required sizes when placing order

Available sizes

Sizes shown here may be slightly differ from the original one due to screen resolution.

- 1 
- 2 
- 3 
- 4 
- 5 
- 6 



Bone Surgery  
12-357-15  
Modell USA Bone Curette  
15.5 cm / 6 "  
Oval, with hollow handle

pls mention required sizes when placing order

Available sizes

Sizes shown here may be slightly differ from the original one due to screen resolution.

- 1 
- 2 
- 3 



Bone Surgery  
12-360-21  
Halle Bone Curette  
21 cm / 8 1/4"  
oval, malleable shaft,  
with hollow handle

pls mention required sizes when placing order

Available Sizes

A: 25 cm / 9 3/4"  
B: 26 cm / 10 1/4"  
C: 27 cm / 10 3/4"



B



C



Bone Surgery  
12-565-00 A / B / C  
Verbrugge  
Bone Holding Forceps

Available in 3 sizes (Length)

- A: 13 cm / 5"
- B: 16 cm / 6 1/4"
- C: 20 cm / 8"



Bone Surgery  
12-366-13 A / B / C  
Volkman Bone Curette,  
double-ended (oval / round).

pls mention required sizes when placing order

Bone Surgery  
12-368-21  
Bone Curette,  
double-ended (round / oval)  
21 cm / 8 1/4"

pls mention required sizes when placing order

Available in 3 sets of combination

- A: 00/0 ● / ●
- B: 0/1 ● / ●
- C: 1/2 ● / ●



Bone Surgery  
12-370-13 A / B / C  
Williger Bone Curette,  
double-ended  
13.5 cm / 5 1/4"

pls mention required sizes when placing order

Available in 3 sets of combination

- A: 00/00 ● / ●
- B: 0/0 ● / ●
- C: 1/1 ● / ●



Bone Surgery  
12-371-17  
Williger Bone Curette,  
17 cm / 6 3/4"  
double-ended oval / oval

pls mention required sizes when placing order

Available in 3 sets of same order faces

- A: 1 R/L ● / ●
- B: 2 R/L ● / ●
- C: 3 R/L ● / ●

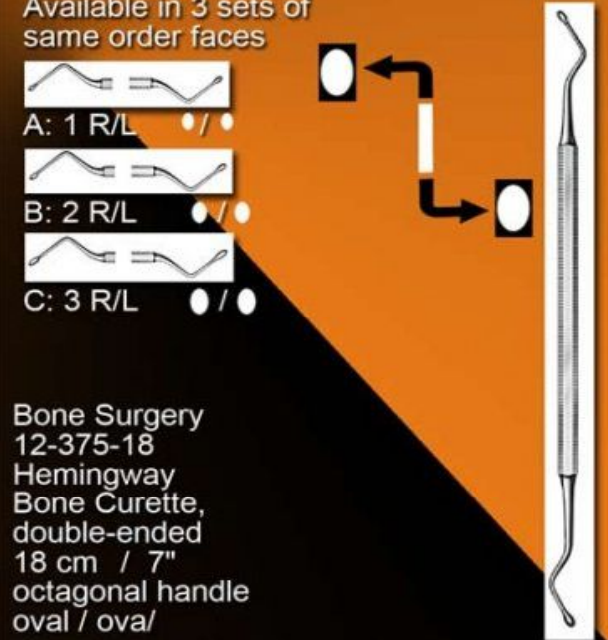


Bone Surgery  
12-374-18  
Hemingway-Martin  
Bone Curette,  
double-ended  
18.5 cm / 7 1/4"  
octagonal handle  
oval / oval

pls mention required sizes when placing order

Available in 3 sets of same order faces

- A: 1 R/L ● / ●
- B: 2 R/L ● / ●
- C: 3 R/L ● / ●



Bone Surgery  
12-375-18  
Hemingway  
Bone Curette,  
double-ended  
18 cm / 7"  
octagonal handle  
oval / ova/

pls mention required sizes when placing order

Available in 3 sets of same order faces



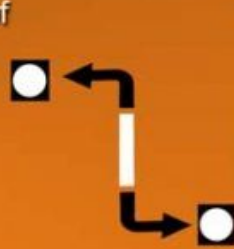
A: 00/00 • / •



B: 0/0 • / •



C: 1/1 • / •



Bone Surgery  
12-376-18  
Hemingway Bone Curette,  
double-ended, round / round  
18.5 cm / 7 1/4"  
octagonal handle

pls mention required sizes when placing order

Available in 4 sizes



A: 1 R/L



B: 2 R/L

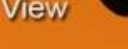
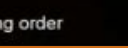
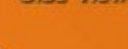


C: 3 R/L



D: 4 R/L

Side View



Bone Surgery  
12-380-18 A / B / C / D  
Lucas Bone Curette,  
double-ended  
18 cm / 7"  
octagonal handle

pls mention required sizes when placing order

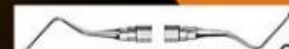
Available in 5 sizes



A



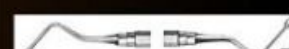
B



C

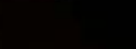
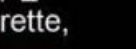
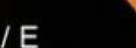
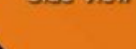


D



E

Side View



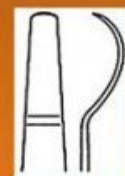
Bone Surgery  
12-382-17 A / B / C / D / E  
Miller-Colburn Bone Curette,  
double-ended  
17 cm / 6 3/4"

pls mention required sizes when placing order



Bone Surgery  
12-385-17  
Molt Bone Curette  
19 cm / 7 1/2"  
Round Handle

pls mention required sizes when placing order



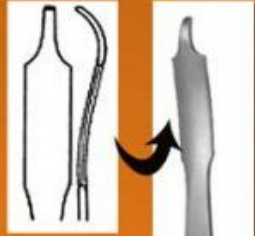
Front /  
Side View



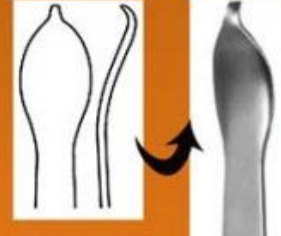
Bone Surgery  
12-470-16  
Bone Lever  
16 cm / 6 1/4"



Bone Surgery  
12-471-16  
Hohman, mini  
Bone Lever  
16 cm / 6 1/4"  
6mm tip



Bone Surgery  
12-472-16  
Hohman, mini  
Bone Lever  
16 cm / 6 1/4"  
8 mm tip



Bone Surgery  
12-473-16  
Hohman, mini  
Bone Lever  
16 cm / 6 1/4"  
14 mm tip



Bone Surgery  
12-476-22  
Hohmann  
Bone Lever  
22 cm / 8 3/4"  
8 mm Tip  
narrow tip



Bone Surgery  
12-476-23  
Hohmann  
Bone Lever  
23.5 cm / 9 1/4"  
18 mm Tip  
narrow tip



Bone Surgery  
12-477-23  
Hohmann  
Bone Lever  
23.5 cm / 9 1/4"  
43 mm Tip  
narrow tip



Bone Surgery  
12-477-25  
Hohmann  
Bone Lever  
25 cm / 9 3/4"  
70 mm Tip  
narrow tip

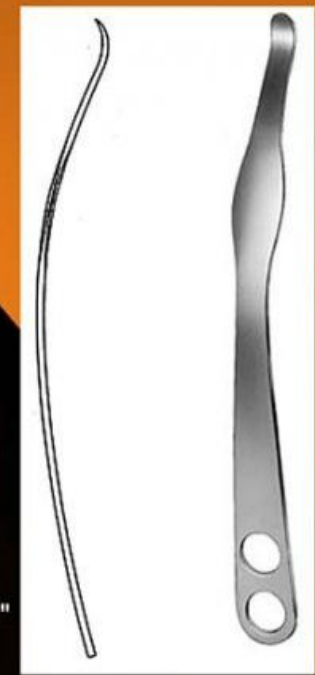




Bone Surgery  
12-479-25  
Hohmann  
Bone Lever  
25.5 cm / 10"  
22mm Tip  
wide tip



Bone Surgery  
12-479-29  
Hohmann  
Bone Lever  
29 cm / 11 1/2"  
35mm Tip  
wide tip



Bone Surgery  
12-480-27  
Hohmann  
Bone Lever  
27.5 cm / 10 3/4"  
24mm Tip  
wide, round tip



Bone Surgery  
12-481-25  
Lange-Hohmann  
Bone Lever  
25 cm / 9 3/4"  
22mm Tip  
wide tip with groove



B: 60 mm



A:  
43 mm

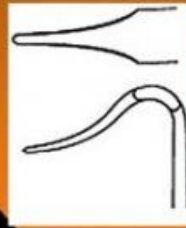
Bone Surgery  
12-484-24 A / B  
Bennett  
Bone Lever  
24 cm / 9 1/2"



Bone Surgery  
12-488-26  
Blount Knee Retractor  
26.5 cm / 10 1/2"  
blunt



Bone Surgery  
12-489-26  
Blount Knee Retractor  
26.5 cm / 10 1/2"



Bone Surgery  
12-490-17  
Blount Knee Retractor  
17.5 cm / 7"



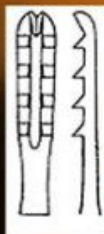
Bone Surgery  
12-491-16 A / B  
Taylor Spinal Retractor  
16 cm / 6 1/4" pointed end



Enlarged



Bone Surgery  
12-530-14  
Bone Holding Forceps  
14 cm / 5 1/2"



Enlarged



Bone Surgery  
12-534-20  
Bircher-Ganske  
Cartilage Seizing Forceps  
20.5 cm / 8"  
Straight



Enlarged



Bone Surgery  
12-535-20  
Bircher-Ganske  
Cartilage Seizing Forceps  
20.5 cm / 8"  
Curved Upward



Enlarged



Bone Surgery  
12-536-20  
Bircher-Ganske  
Cartilage Seizing Forceps  
20 cm / 8"  
Curved Sidwards



Enlarged



Bone Surgery  
12-538-18  
Dingmann Cartilage Seizing Forceps  
18.5 cm / 7 1/4"



Enlarged



Bone Surgery  
12-540-18  
Martin Cartilage Seizing Forceps  
18.5 cm / 7 1/4"



Enlarged



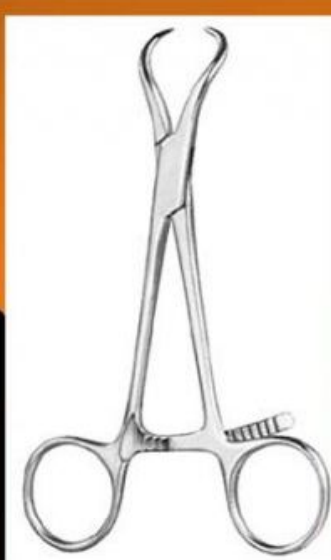
Bone Surgery  
12-544-13  
Reposition Forceps  
13.5 cm / 5 1/4"  
Long ratchet pointed



Enlarged



Bone Surgery  
12-546-18  
Lewin Bone Holding Forceps  
18.5 cm / 7 1/4"



Bone Surgery  
12-548-15  
Reposition Forceps  
15 cm / 6"  
Long Ratchet Pointed



Enlarged



Bone Surgery  
12-550-21  
Langenbeck  
Bone Holding Forceps  
21 cm / 8 1/4"



Enlarged



Bone Surgery  
12-551-21  
Fergusson  
Bone Holding Forceps  
21 cm / 8 1/4"  
Heavy pattern



Enlarged



Bone Surgery  
12-552-18  
Frosch  
Bone Holding Forceps  
18 cm / 7"



Enlarged



Bone Surgery  
12-553-20  
Bone Holding Forceps  
20 cm / 8"



Enlarged



Bone Surgery  
12-555-17  
Reposition Forceps  
17 cm / 6 3/4"  
with Thread Fixation



Enlarged



Bone Surgery  
12-555-24  
Reposition Forceps  
24 cm / 9 1/2"  
with Thread Fixation

A: 17cm / 6 3/4"



Other available size



B: 21cm / 8 1/4"

Bone Surgery  
12-556-17 A / B  
Kern  
Bone Holding Forceps

A: 21cm / 8 1/4"



Other available size



B: 17cm / 6 3/4"

Bone Surgery  
12-556-21 A / B  
Kern  
Bone Holding Forceps  
without Ratchet



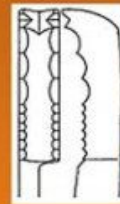
Enlarged



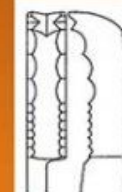
Bone Surgery  
12-547-14  
Bone Holding Forceps  
14 cm / 5 1/2"  
Delicate



Bone Surgery  
12-557-19  
Semb  
Bone Holding Forceps  
19 cm / 7 1/2"



Bone Surgery  
12-558-23  
Farabeuf  
Bone Holding Forceps  
23cm / 9" &  
26 cm / 10 1/4"



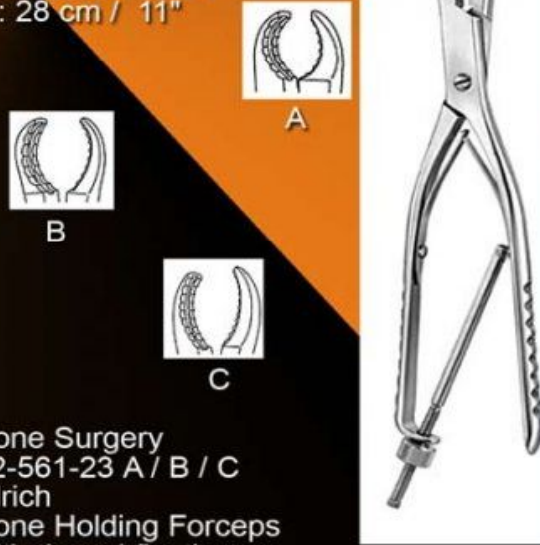
Bone Surgery  
12-559-26  
Farabeuf  
Bone Holding Forceps  
26 cm / 10 1/4"

Available Sizes  
 22 cm / 8 3/4"  
 27 cm / 10 3/4"  
 30 cm / 11 3/4"



Bone Surgery  
 12-560-22  
 Lambotte  
 Bone Holding Forceps  
 one flexible jaw

Available Sizes  
 A: 23 cm / 9"  
 B: 25 cm / 9 3/4"  
 C: 28 cm / 11"



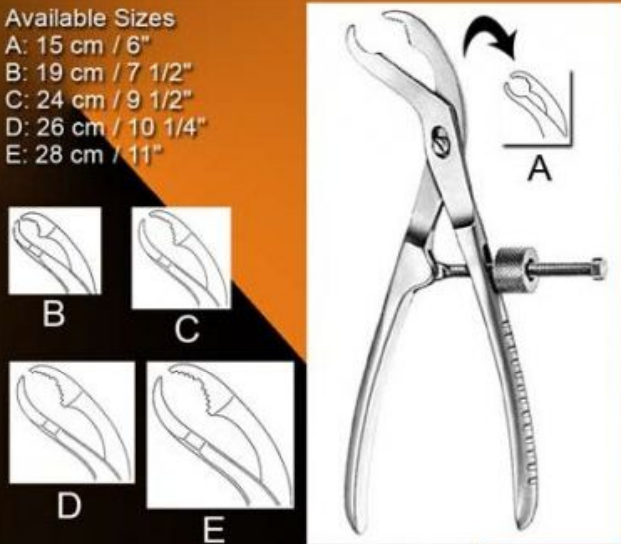
Bone Surgery  
 12-561-23 A / B / C  
 Ulrich  
 Bone Holding Forceps  
 with thread fixation

Available Sizes  
 A: 22 cm / 8 3/4"  
 B: 24 cm / 9 1/2"  
 C: 27 cm / 10 3/4"

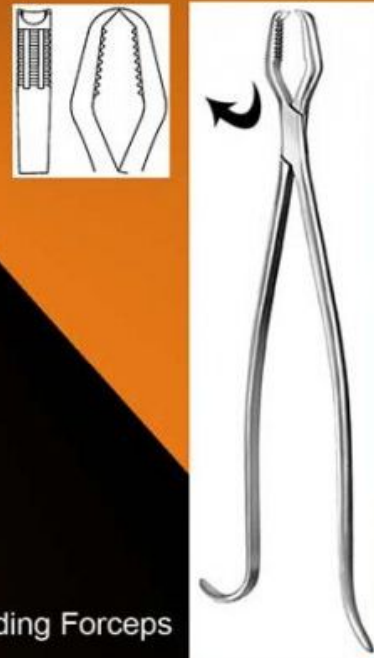


Bone Surgery  
 12-562-22 A / B / C  
 Ulrich  
 Bone Holding Forceps  
 with thread fixation

Available Sizes  
 A: 15 cm / 6"  
 B: 19 cm / 7 1/2"  
 C: 24 cm / 9 1/2"  
 D: 26 cm / 10 1/4"  
 E: 28 cm / 11"



Bone Surgery  
 12-563-00 A / B / C / D / E  
 Bone Holding Forceps  
 self-centering with thread fixation



Bone Surgery  
 12-564-33  
 Lane Bone Holding Forceps  
 33 cm / 13"  
 With and without ratchet



Bone Surgery  
 12-565-17  
 Verbrugge  
 Bone Holding Forceps  
 17.5 cm / 7"



Bone Surgery  
12-570-00  
Percy Amputation Retractor  
Detachable

Available Patterns



A:  
17.5 cm / 7"  
Semi curved



B:  
16.5 cm / 6 1/2"  
Curved



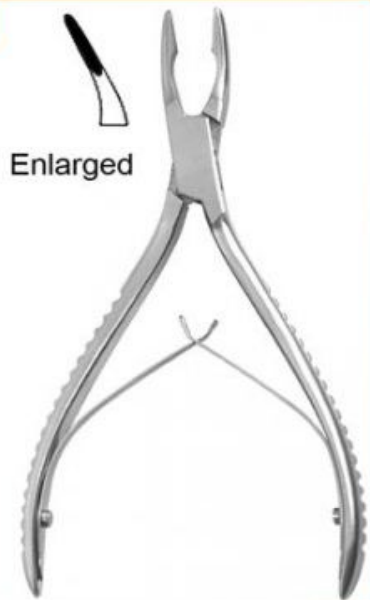
Bone Surgery  
12-575-17 A / B  
Stellbrink Bone Rongeur



Enlarged



Bone Surgery  
12-576-12  
Friedmann  
Bone Rongeur  
12.5 cm / 5"



Enlarged

Bone Surgery  
12-577-13  
Friedmann  
Bone Rongeur  
13.5 cm / 5 1/4"



Enlarged



Bone Surgery  
12-578-13  
Cleveland  
Bone Rongeur  
13.5 cm / 5 1/4"



Enlarged



Bone Surgery  
12-578-16  
Cleveland  
Bone Rongeur  
16.5 cm / 6 1/2"



Enlarged



Bone Surgery  
12-579-16  
Mead  
Bone Rongeur  
16.5 cm / 6 1/2"



Enlarged



Bone Surgery  
12-580-17  
Hartmann  
Bone Rongeur  
17.5 cm / 7"

Other Pattern



B:  
Curved



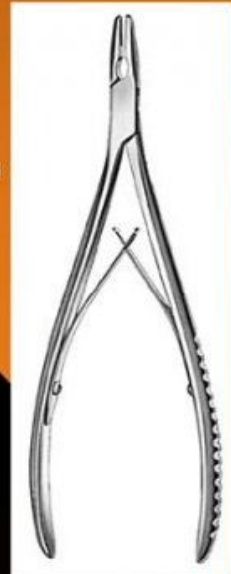
A:  
Straight



Bone Surgery  
12-581-18 A / B  
Jansen  
Bone Rongeur  
18 cm / 7"



Enlarged



Bone Surgery  
12-582-19  
Lempert  
Bone Rongeur  
19 cm / 7 1/2"



A



Other  
available Pattern



B (18cm / 7")  
Semi Curved

Bone Surgery  
12-584-18 A / B  
Luer Bone Rongeur  
18.5 cm / 7 1/4" (A)

Other  
available Pattern



B



A



C

Bone Surgery  
12-585-14 A / B / C  
Luer Bone Rongeur  
14.5 cm / 5 3/4"



Other available Pattern



B



A



Bone Surgery  
12-586-15 A / B  
Böhler Bone Rongeur  
15.5 cm / 6"



Bone Surgery  
12-587-18  
Beyer Bone Rongeur  
18 cm / 7"



Bone Surgery  
12-588-18  
Zaufal-Jansen  
Bone Rongeur  
18 cm / 7"



Bone Surgery  
12-589-18  
Mayfield Bone Rongeur  
18 cm / 7"



Bone Surgery  
12-590-20  
Marquard  
Bone Rongeur  
20.5 cm / 8"



Bone Surgery  
12-591-19  
Ruskin  
Bone Rongeur  
19 cm / 7 1/2"



Bone Surgery  
12-592-24  
Ruskin  
Bone Rongeur  
24 cm / 9 1/2"

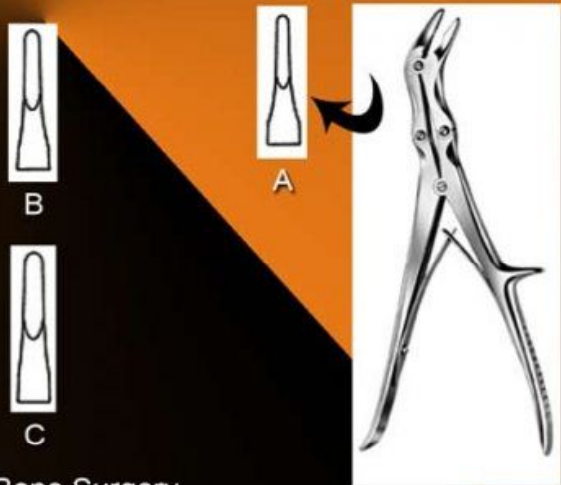


Bone Surgery  
12-593-23  
Semb  
Bone Rongeur  
23.5 cm / 9 1/4"



Bone Surgery  
12-594-22  
Stille Bone Rongeur  
22.5 cm / 8 3/4"

Other Sizes

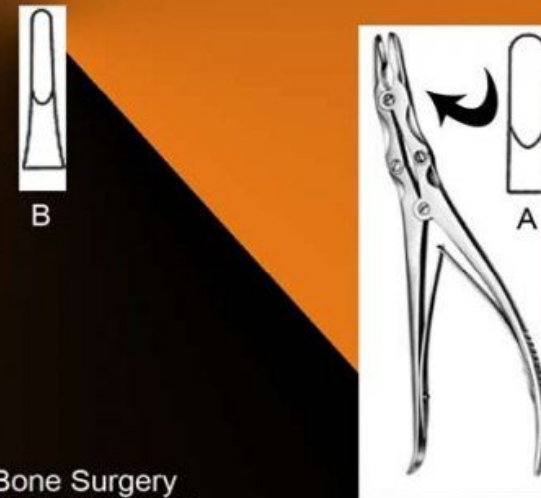


Bone Surgery  
12-595-23 A / B / C  
Stille Bone Rongeur  
22.5 cm / 8 3/4"

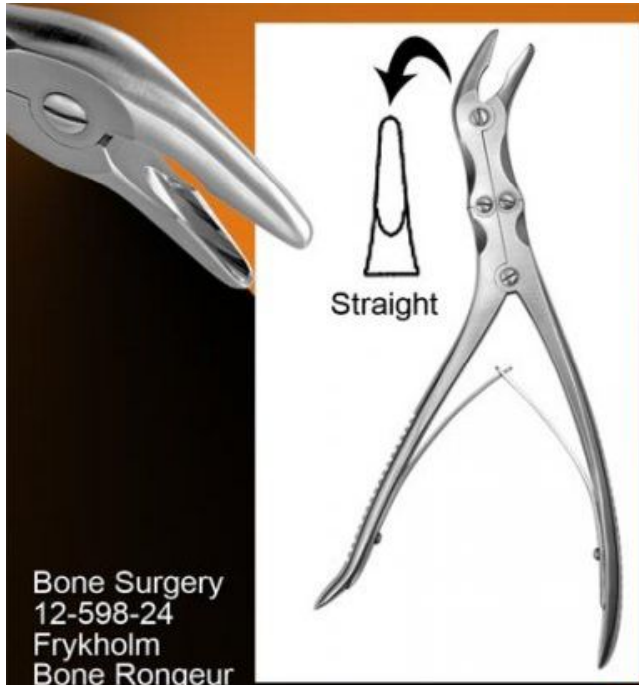


Bone Surgery  
12-596-23  
Stille-Ruskin Bone Rongeur  
23.5 cm / 9 1/4"

Other Size

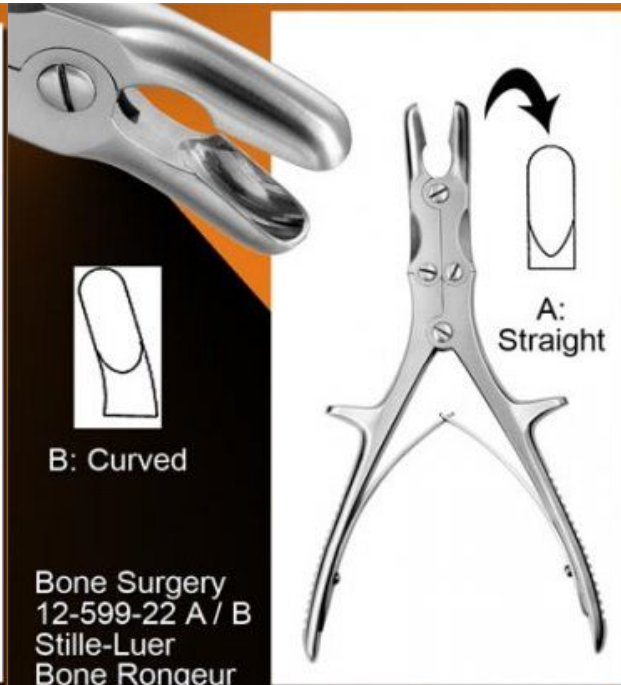


Bone Surgery  
12-597-24 A / B  
Leksell-Stille  
Bone Rongeur  
24.5 cm / 9 3/4"



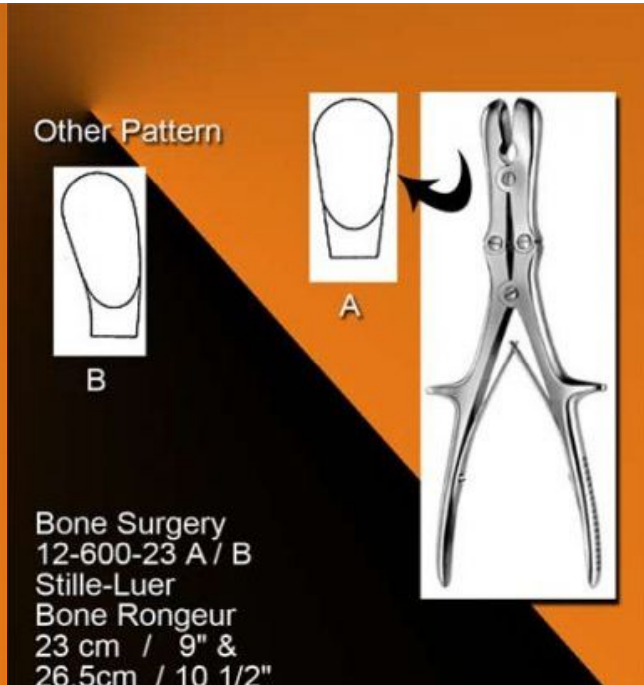
Straight

Bone Surgery  
12-598-24  
Frykholm  
Bone Rongeur  
24.5 cm / 9 3/4"



B: Curved

Bone Surgery  
12-599-22 A / B  
Stille-Luer  
Bone Rongeur  
22.5 cm / 8 3/4"



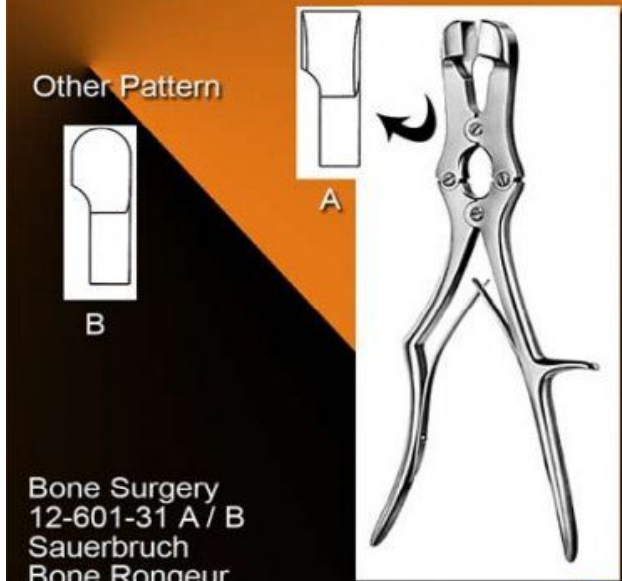
Other Pattern

B

A

Bone Surgery  
12-600-23 A / B  
Stille-Luer  
Bone Rongeur  
23 cm / 9" &  
26.5cm / 10 1/2"

Pls mention sizes / patterns when inquire



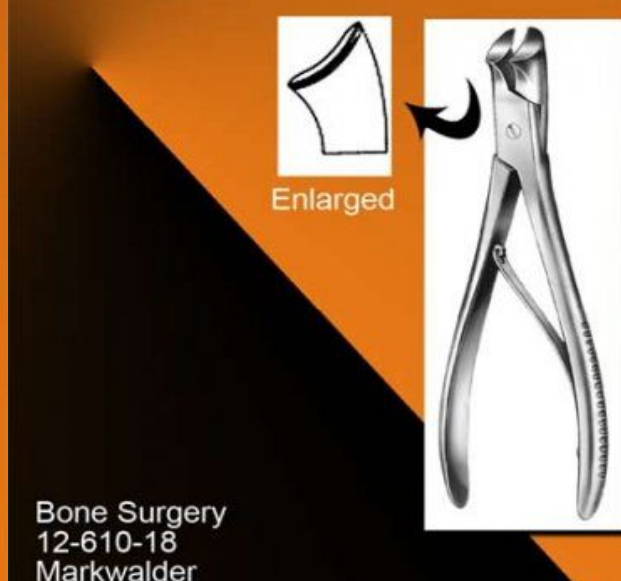
Other Pattern

B

A

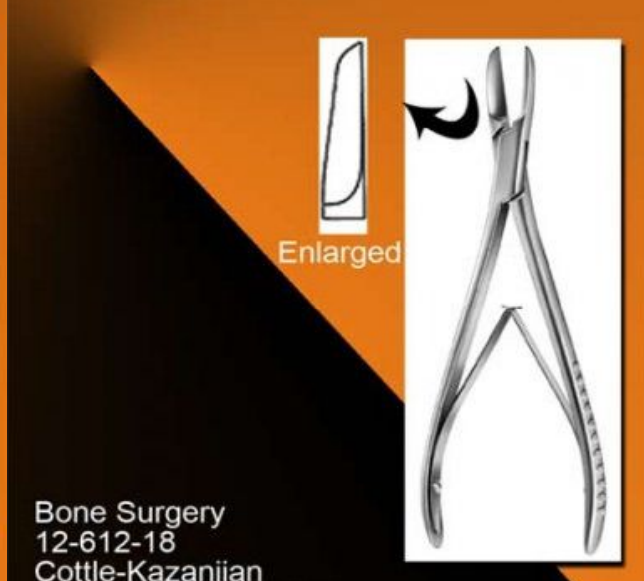
Bone Surgery  
12-601-31 A / B  
Sauerbruch  
Bone Rongeur  
31 cm / 12 1/4"

Pls mention sizes / patterns when inquire



Enlarged

Bone Surgery  
12-610-18  
Markwalder  
Bone Nipper  
18.5 cm / 7 1/4"



Enlarged

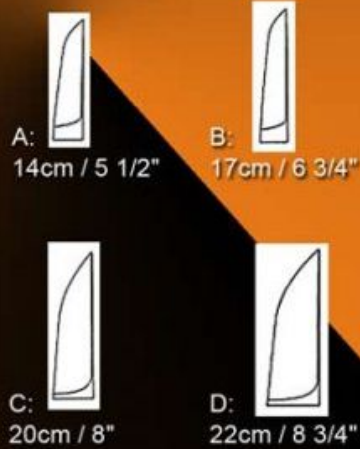
Bone Surgery  
12-612-18  
Cottle-Kazanjan  
Bone Cutting Forceps  
18.5 cm / 7 1/4"



Enlarged

Bone Surgery  
12-612-18  
Cottle-Kazanjian  
Bone Cutting Forceps  
18.5 cm / 7 1/4"

Available Sizes



A:  
14cm / 5 1/2"

B:  
17cm / 6 3/4"

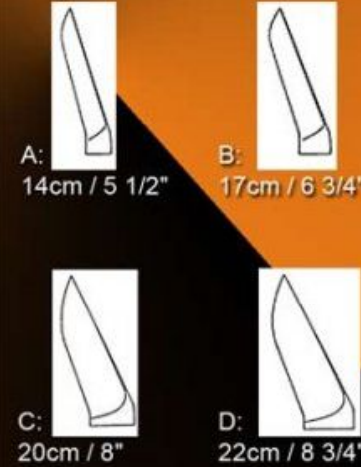
C:  
20cm / 8"

D:  
22cm / 8 3/4"



Bone Surgery  
12-614-00 A / B / C / D  
Liston  
Bone Cutting Forceps  
Sizes (full length) are shown with enlarged blade images  
Pls add sizes / patterns when inquire.

Available Sizes



A:  
14cm / 5 1/2"

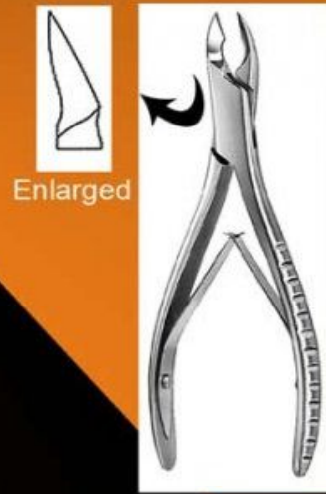
B:  
17cm / 6 3/4"

C:  
20cm / 8"

D:  
22cm / 8 3/4"



Bone Surgery  
12-615-00 A / B / C / D  
Liston  
Bone Cutting Forceps  
Sizes (full length) are shown with enlarged blade images  
Pls add sizes / patterns when inquire.



Enlarged

Bone Surgery  
12-616-17  
Cleveland  
Bone Cutting Forceps  
17 cm / 6 3/4"



Enlarged

Bone Surgery  
12-617-14  
Cleveland  
Bone Cutting Forceps  
14.5 cm / 5 3/4"



Enlarged

Bone Surgery  
12-628-24  
Semb  
Bone Cutting Forceps  
24.5 cm / 9 3/4"



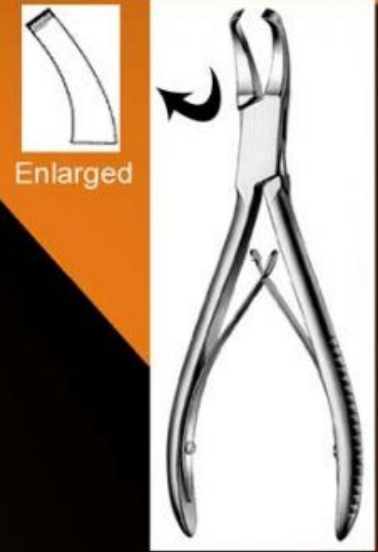
Enlarged

Bone Surgery  
12-620-14  
Böhler  
Bone Cutting Forceps  
14.5 cm / 5 3/4"



Enlarged

Bone Surgery  
12-621-14  
Böhler  
Bone Cutting Forceps  
14.5 cm / 5 3/4"



Enlarged

Bone Surgery  
12-622-16  
Cleveland  
Bone Cutting Forceps  
16 cm / 6 1/4"

Other Pattern



B



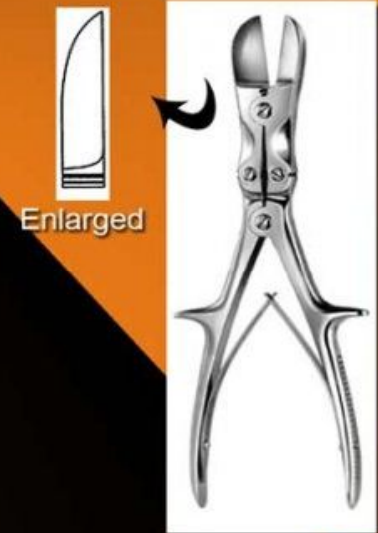
A

Bone Surgery  
12-623-18 A / B  
Ruskin-Liston  
Bone Cutting Forceps  
18 cm / 7"  
Pls add sizes / patterns when inquire.



Enlarged

Bone Surgery  
12-624-26  
Stille-Liston  
Bone Cutting Forceps  
26 cm / 10 1/4"



Enlarged

Bone Surgery  
12-625-27  
Stille-Liston  
Bone Cutting Forceps  
27.5 cm / 10 3/4"



Enlarged



Bone Surgery  
12-626-00  
Stille-Liston  
Bone Cutting Forceps  
23.5 cm / 9 1/4" &  
27.5 cm / 10 3/4"

Pls add required size when inquire



Enlarged



Bone Surgery  
12-626-00  
Stille-Liston  
Bone Cutting Forceps  
23.5 cm / 9 1/4" &  
27.5 cm / 10 3/4"

Pls add required size when inquire



Enlarged



Bone Surgery  
12-627-25  
Liston-Key  
Bone Cutting Forceps  
25.5 cm / 10"



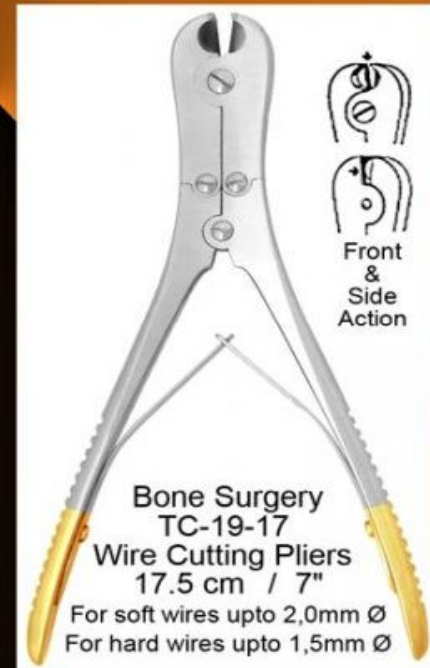
Enlarged



Bone Surgery  
12-628-24  
Semb  
Bone Cutting Forceps  
24.5 cm / 9 3/4"

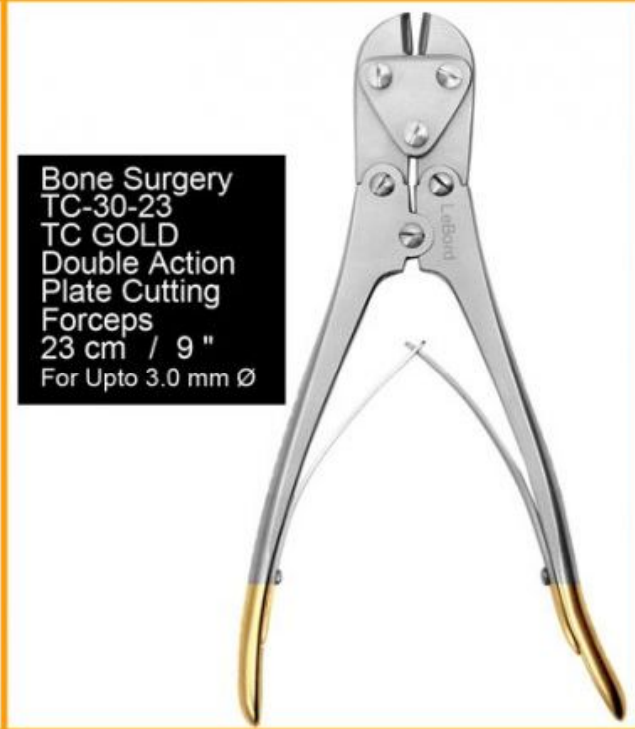


Bone Surgery  
TC-14-17  
Martin  
"Gigant-Compact" Wire Cutting Pliers  
17.5 cm / 7"  
For hard wires upto 2,2mm Ø



Front  
&  
Side  
Action

Bone Surgery  
TC-19-17  
Wire Cutting Pliers  
17.5 cm / 7"  
For soft wires upto 2,0mm Ø  
For hard wires upto 1,5mm Ø





**CUSHING**  
Intervertebral Discs Rongeur



**LOVE-GRUENWALD**  
Intervertebral Discs Rongeur



**SPURLING**  
Intervertebral Discs Rongeur

**LBP-1010**  
**CUSHING**  
Intervertebral Discs Rongeur

**2X10mm Bite**

Available Shaft Sizes: 5" / 6" / 7" / 8"  
/ 9" / 10" / 11" / 12"  
Straight - Up - Down

**LBP-1015**  
**LOVE-GRUENWALD**  
Intervertebral Discs Rongeur

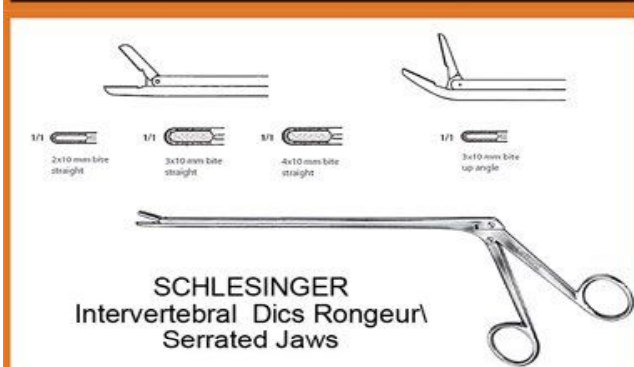
**3X10mm Bite**

Available Shaft Sizes: 5" / 6" / 7" / 8"  
/ 9" / 10" / 11" / 12"  
Straight - Up - Down

**LBP-1020**  
**SPURLING**  
Intervertebral Discs Rongeur

**4X10mm Bite**

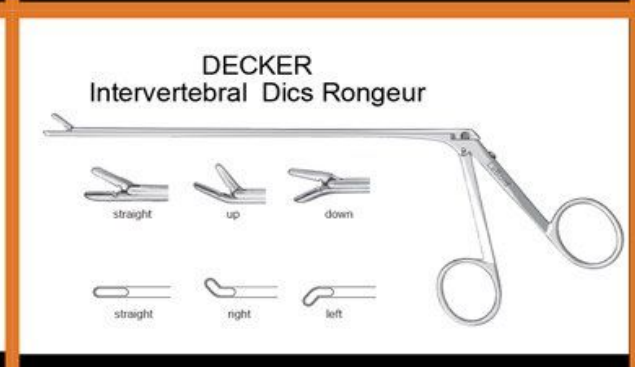
Available Shaft Sizes: 5" / 6" / 7" / 8"  
/ 9" / 10" / 11" / 12"  
Straight - Up - Down



**SCHLESINGER**  
Intervertebral Discs Rongeur  
Serrated Jaws



**CASPAR**  
Intervertebral Discs Rongeur  
Fenestrated Cup  
Side Serrated Jaws



**DECKER**  
Intervertebral Discs Rongeur

**LBP-1025**

|  |                              |  |                          |
|--|------------------------------|--|--------------------------|
| <b>6" Straight</b><br>2X10mm<br>3X10mm<br>4X10mm | <b>7" Straight</b><br>2X10mm | <b>9" Straight</b><br>2X10mm<br>3X10mm<br>5X10mm | <b>9" Down</b><br>2X10mm |
| <b>6" UP</b><br>3X10mm                           | <b>7" UP</b><br>2X10mm       | <b>9" UP</b><br>2X10mm<br>3X10mm<br>5X10mm       |                          |

**LBP-1030**

|  |  |                                    |
|--|--|------------------------------------|
| <b>6" Straight</b><br>2X12mm<br>3X12mm<br>4X14mm<br>5X14mm | <b>7" Straight</b><br>2X12mm<br>3X12mm<br>4X14mm<br>5X14mm<br>6X14mm | <b>7" Down</b><br>3X12mm<br>4X14mm |
| <b>6" UP</b><br>2X12mm<br>3X12mm<br>4X14mm<br>5X14mm       | <b>7" UP</b><br>2X12mm<br>3X12mm<br>4X14mm<br>5X14mm                 |                                    |

**LBP-1035**

6" Shaft Size

Straight UP Down Right Left

**BITE SIZE**  
**2X6mm**





**TAKAHASHI**  
Intervertebral Discs Rongeur

LBP-1040

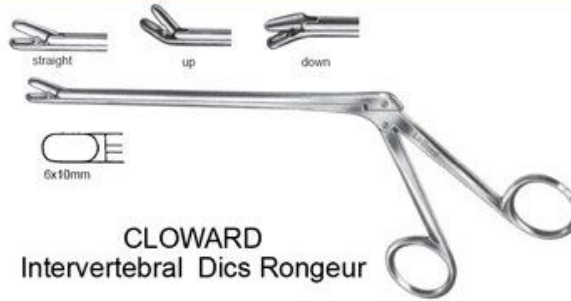
5 or 5.5" Shaft Size

Straight

BITE SIZE

3X8mm

4X8mm



**CLOWARD**  
Intervertebral Discs Rongeur

LBP-1045

6" Shaft Size

Straight Up Down

BITE SIZE

6X10mm



**SELVERSTONE**  
Intervertebral Discs Rongeur

LBP-1050

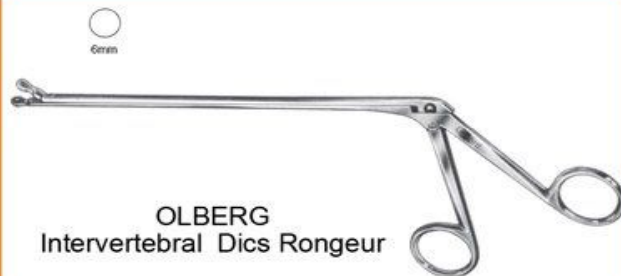
6" Shaft Size

Straight

BITE SIZES

2X3mm

2X5mm



**OLBERG**  
Intervertebral Discs Rongeur

LBP-1060

7" Shaft Size

Straight

BITE SIZE

6mm Round



**WILDE**  
Intervertebral Discs Rongeur

LBP-1065

5" Shaft Size

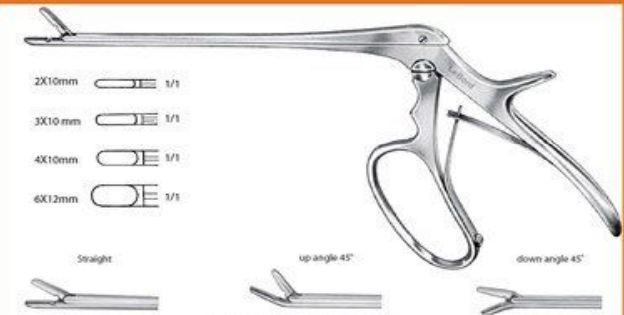
Fenestrated Jaws Straight

BITE SIZES

4X9mm Small

5X10mm Medium

6X11mm Large



**FERRIS SMITH**  
Intervertebral Discs Rongeur

LBP-1070

7" Shaft Size  
Straight Up Down

BITE SIZES

2X10mm

3X10mm

4X10mm

6X10mm



5 1/2" 90° down 3mm

**HAJEK-KOFLER**  
Rongeur  
w/regular footplate

**LBP-1105**

5 1/2" 90° Down

**BITE SIZES**  
3mm



2mm 3mm 4mm 5mm 6mm

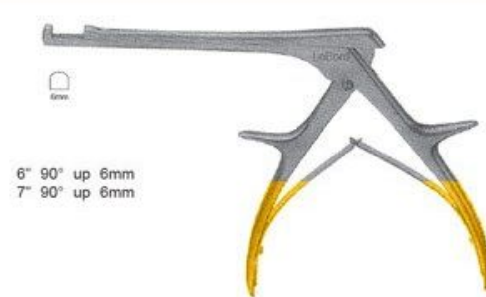
4" 90° up 2mm  
4" 90° up 3mm  
4" 90° up 4mm  
4" 90° up 5mm  
4" 90° up 6mm

**KERRISON MASTOID**  
Rongeur / Punch  
w/regular footplate

**LBP-1110**

4" 90° Up

**BITE SIZES**  
2mm / 3mm / 4mm / 5mm / 6mm



6" 90° up 6mm  
7" 90° up 6mm

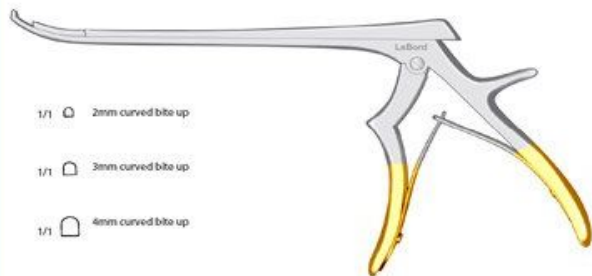
**RANEY**  
Rongeur / Punch

**LBP-1115**

6" 90° UP

7" 90° UP

**BITE SIZES**  
6mm



1/1 2mm curved bite up

1/1 3mm curved bite up

1/1 4mm curved bite up

**FORAMENOTOMY**  
Rongeur / Punch

**LBP-1120**

8" Curved UP  
Upward Curved Shaft and  
Forward Angle Footplate

**BITE SIZES**  
2mm / 3mm / 4mm



90° down bite  
40° forward bite  
90° up bite

*Regular Foot Plate*

1mm 2mm 3mm 4mm 5mm 6mm

Compact Handles

**SPURLING KERRISON**  
Rongeur / Punch

**LBP-1125**

Shaft Sizes: 7" / 8" / 9" / 10" and 11"  
90° Down / 40° Forward / 90° Up  
w/regular footplate

**BITE SIZES**  
1mm / 2mm / 3mm / 4mm  
5mm / 6mm

**Note:** 9" / 10" and 11" are available in Forward only.



40° forward bite  
90° up bite

Down 90°

*Thin Foot Plate*

1mm 2mm 3mm 4mm 5mm 6mm

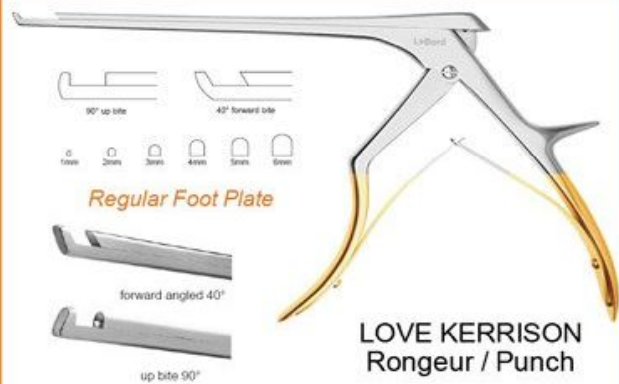
**SPURLING KERRISON**  
Rongeur / Punch

**LBP-1130**

Shaft Sizes: 6" / 7" / 8" / 9"  
90° Down / 40° Forward / 90° Up  
w/ thin foot plate

**BITE SIZES**  
1mm / 2mm / 3mm / 4mm  
5mm / 6mm

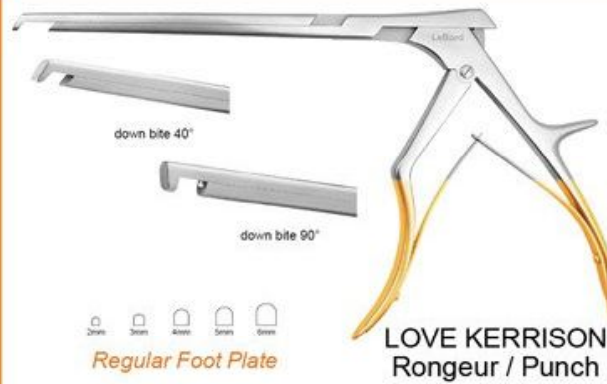
**Note:** 6" and 9" are available in Forward only.



LOVE KERRISON  
Rongeur / Punch

**LBP-1135**  
Shaft Sizes: 6" / 7" / 8" / 9" / 10" / 11"  
90° Up / 40° Forward  
w/ regular foot plate

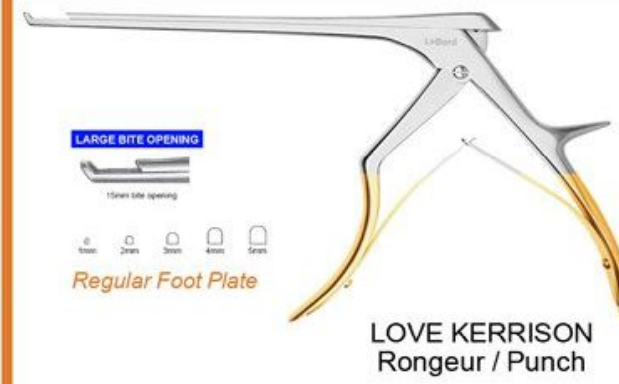
**BITE SIZES**  
1mm / 2mm / 3mm / 4mm  
5mm / 6mm  
10" and 11" available in 4 & 6mm FORWARD



LOVE KERRISON  
Rongeur / Punch

**LBP-1135B**  
Shaft Sizes: 6" / 7" / 8" / 9"  
90° Down / 40° Down  
w/ regular foot plate

**BITE SIZES**  
2mm / 3mm / 4mm  
5mm / 6mm



LOVE KERRISON  
Rongeur / Punch

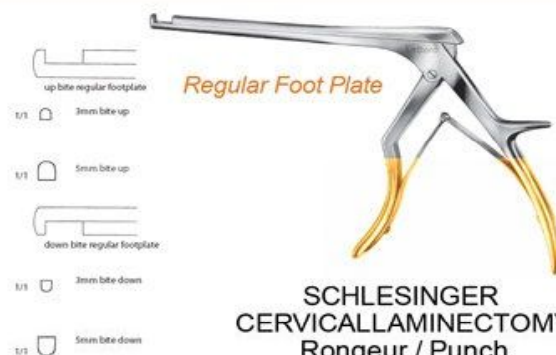
**LBP-1140**  
Shaft Sizes: 6" / 7" / 8"  
40° Forward  
w/ regular foot plate  
**BITE SIZES**  
1X15mm / 2X15mm / 3X15mm /  
4X15mm / 5X15mm / 6X15mm



FERRIS SMITH  
Rongeur / Punch

**LBP-1150**  
Shaft Sizes: 7" / 8"  
40° Forward  
w/ regular foot plate

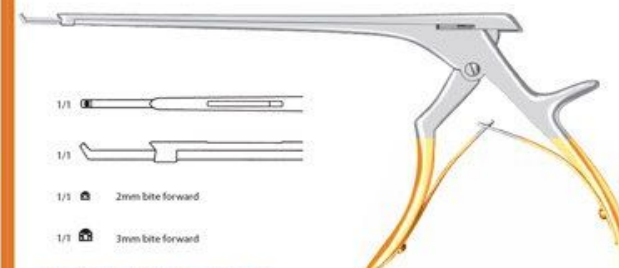
**BITE SIZES**  
3mm / 5mm  
**RING HANDLE STYLE**



SCHLESINGER  
CERVICALLAMINECTOMY  
Rongeur / Punch

**LBP-1155**  
Shaft Sizes: 6"  
UP Bite and DOWN Bite  
w/ regular foot plate

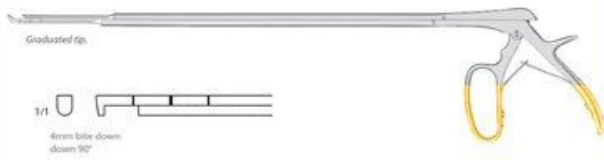
**BITE SIZES**  
3mm / 5mm



MULTI-BITE KERRISON  
Rongeur / Punch

**LBP-1160**  
Shaft Sizes: 7"  
Forward Bite  
w/ delicate thin foot plate

**BITE SIZES**  
2mm / 3mm



Regular Foot plate

FERRI SMITH KERRISON  
ENDOSCOPIC Punch

**LBP-1165**  
Total 20" Length  
Shaft Sizes: 10.3/4" / TIP Length: 3 1/4"  
Handle Length: 6"  
w/ regular foot plate

BITE SIZES  
4mm Down

**LBR-1525**  
GELPI  
SELF RETAINING  
RETRACTOR



Sharp Points  
A: 3 1/2 Inches  
B: 4 1/2 Inches  
C: 5 1/2 Inches  
D: 7 1/2 Inches

Blunt Points  
E: 7 1/2 Inches



**LBR-1526**  
GELPI-SELETZ  
SELF RETAINING RETRACTOR  
DEEP BLADES  
Sharp Points  
6 1/4 Inches

2x8mm

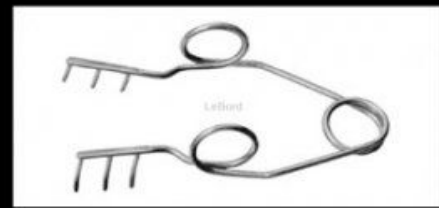


PEAPOD  
Intervertebral Discs Rongeur

5.1/2" Shaft Size  
Upward  
BITE SIZE  
**2X6mm**



**LBR-1504**  
FINZEN  
SELF RETAINING RETRACTOR  
6.5cm / 2 3/4 Inches



**LBR-1506**  
SELF RETAINING RETRACTOR  
FAT RETRACTOR  
6cm / 2 1/8 Inches



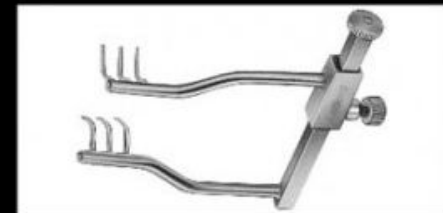
**LBR-1507**  
SELF RETAINING RETRACTOR  
4X4 BLUNT PRONGS  
10cm / 4 Inches



**LBR-1507B**  
SELF RETAINING RETRACTOR  
4X4 SHARP PRONGS  
10cm / 4 Inches



**LBR-1508**  
ALM  
SELF RETAINING RETRACTOR  
BLUNT  
A: 2 3/4 Inches  
10cm / 4 Inches



**LBR-1509**  
LOGAN  
SELF RETAINING RETRACTOR  
SEMI-SHARP  
5cm / 2 Inches



**LBR-1510**  
PARSONNET  
SELF-RETAINING RETRACTOR  
3X3 PRONGS  
6.5cm / 2 Inches



**LBR-1512**  
ALLPORT  
SELF RETAINING RETRACTOR  
SHARP  
3 3/4 Inches



**LBR-1513A**  
JANSEN  
SELF RETAINING RETRACTOR  
3X3 SEMI-SHARP 4 Inches



**LBR-1513B**  
JANSEN  
SELF RETAINING RETRACTOR  
3X3 BLUNT 4 Inches



**LBR-1513A**  
**JANSEN**  
 SELF RETAINING RETRACTOR  
 3X3 SEMI-SHARP 4 Inches



**LBR-1513B**  
**JANSEN**  
 SELF RETAINING RETRACTOR  
 3X3 BLUNT 4 Inches



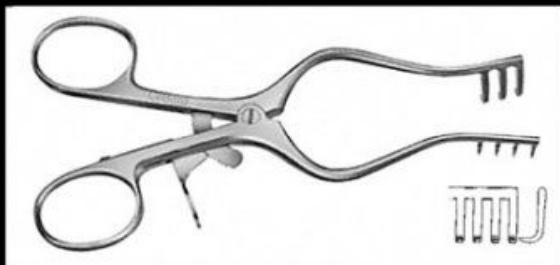
**LBR-1514**  
**JANSEN**  
 SELF RETAINING RETRACTOR  
 3X4 BLUNT 4 Inches



**LBR-1515**  
**WEITLANER**  
 SELF RETAINING RETRACTOR  
 4 3/8 Inches  
 13mm Depth X 13mm Height

2X3 Prongs

A: SEMI-SHARP  
 B: SHARP  
 C: BLUNT



**LBR-1516**  
**WEITLANER**  
 SELF RETAINING RETRACTOR  
 3X4 Prongs

A: 5 1/2 Inches (14X18mm Prongs)  
 B: 6 1/2 Inches (15X20mm Prongs)  
 C: 8 Inches (16X20mm Prongs)  
 D: 9 1/2 Inches (23X21mm Prongs)

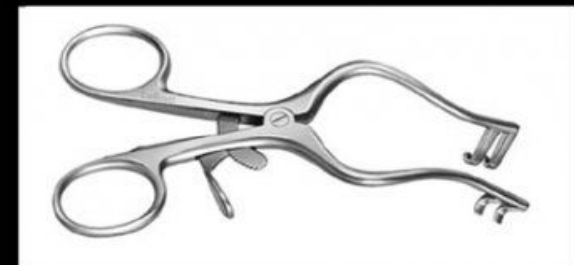
Available POINTS:  
 SEMI-SHARP - SHARP - BLUNT



**LBR-1517**  
**WULLSTEIN**  
 SELF RETAINING RETRACTOR  
 5 1/8 Inches

3X3 Prongs

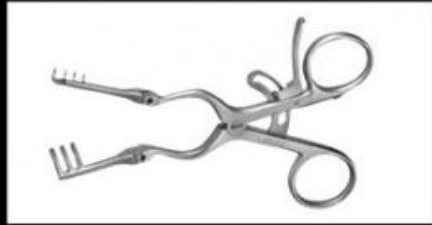
A: SHARP  
 C: BLUNT



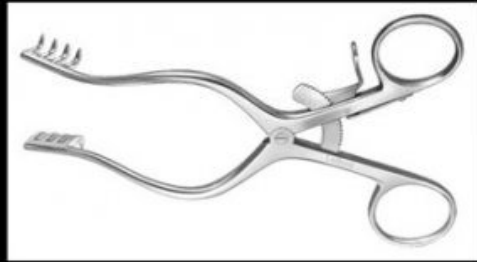
**LBR-1518**  
**PLESTER**  
 SELF RETAINING RETRACTOR  
 5 1/8Inches

2X2 Prongs

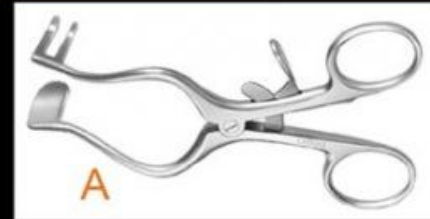
A: SHARP  
 C: BLUNT



**LBR-1519**  
BABY ADSON  
SELF RETAINING RETRACTOR  
SEMI-SHARP,  
WITH JOINT  
5 1/2 Inches  
  
4X3 Prongs



**LBR-1520**  
MOLLISON  
SELF RETAINING RETRACTOR  
SHARP 6 Inches  
  
4X4 Prongs



A



B

**LBR-1521**  
PLESTER  
SELF RETAINING RETRACTOR  
BLUNT  
4 3/8 Inches



**LBR-1522**  
JEFFERSON  
SELF RETAINING RETRACTOR  
CURVED, BLUNT  
5 1/2 Inches



**LBR-1523**  
MOLLISON  
SELF RETAINING RETRACTOR  
SHARP  
5 1/2 Inches



**LBR-1524**  
COX METATARSALSPREADER  
SELF RETAINING RETRACTOR  
4 1/2 Inches  
8mm X 28mm Blades

LBR-1525  
GELPI  
SELF RETAINING  
RETRACTOR

Sharp Points  
A: 3 1/2 Inches  
B: 4 1/2 Inches  
C: 5 1/2 Inches  
D: 7 1/2 Inches

Blunt Points  
E: 7 1/2 Inches



LBR-1526  
GELPI-SELETZ  
SELF RETAINING RETRACTOR  
DEEP BLADES  
Sharp Points  
6 1/4 Inches



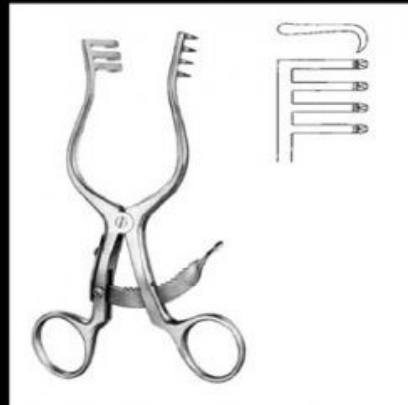
LBR-1527  
GELPI  
SELF RETAINING RETRACTOR  
Sharp Points w/Ball Stops  
7 Inches



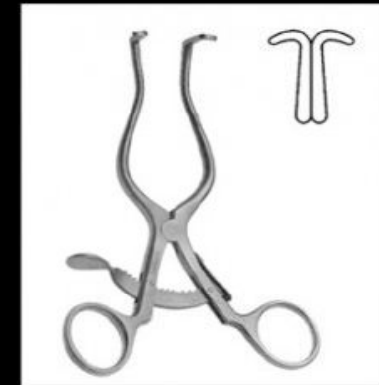
LBR-1528  
WILTSE GELPI  
SELF RETAINING RETRACTOR  
Deep Blades Sharp Points  
11 Inches



LBR-1529  
SCALP CONTOUR  
SELF RETAINING RETRACTOR  
15mm depth X 20mm height  
A: 5 1/2 In 3X4 Sharp  
B: 5 1/2 In 3X4 Blunt



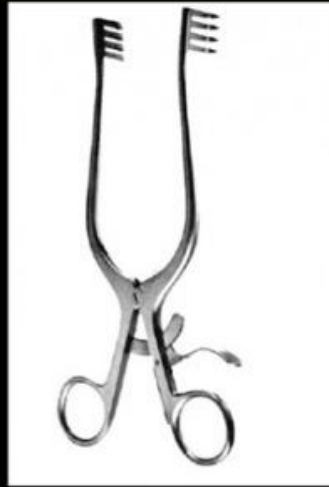
LBR-1530  
TISSUE  
SELF RETAINING RETRACTOR  
13mm depth  
5 1/4 Inches







LBR-1531  
BECKMAN-WEITLANER  
SELF RETAINING RETRACTOR  
HINGED BLADES  
A: 5 1/2" 3x4 20x15mm  
B: 6 1/2" 3x4 20x15mm  
C: 8 1/2" 3x4 22x17mm  
D: 9 1/2" 3x4 22x24mm  
SHARP or BLUNT



LBR-1532  
ADSON  
SELF RETAINING RETRACTOR  
7.5 Inches STR  
A: 4X4 SHARP 18mm X 18mm  
B: 4X4 BLUNT 18mm X 18mm



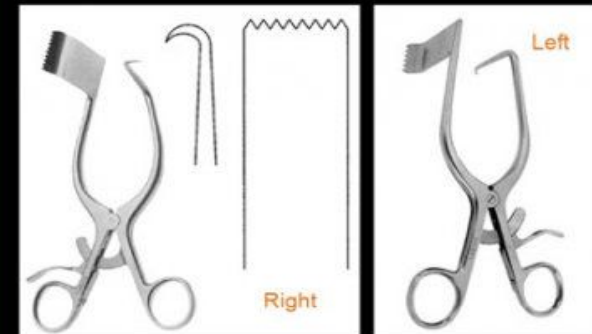
LBR-1533  
ADSON  
SELF RETAINING RETRACTOR  
7.5 Inches ANGLED  
A: 4X4 SHARP 18mm X 18mm  
B: 4X4 BLUNT 18mm X 18mm



LBR-1534  
D'ERRICO-ADSON  
SELF RETAINING RETRACTOR  
7 1/2 Inches  
4X4 SHARP 22mm X19mm



LBR-1535  
MISKIMON CEREBELLUM  
SELF RETAINING RETRACTOR  
7 1/2 Inches  
7X7 SHARP 35mm X32mm



LBR-1536  
MARKHAM - MEYERDING  
HEMILAMINECTOMY  
SELF RETAINING RETRACTOR  
7 Inches  
A: Right SHARP Blade 60mm X25mm  
B: Left SHARP Blade 60mm X25mm

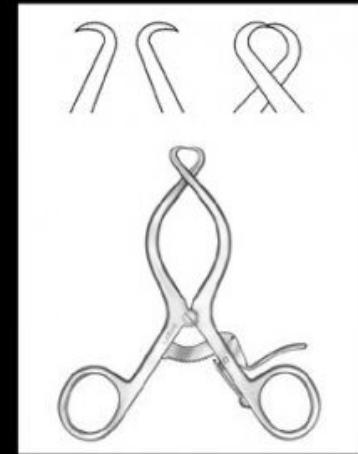


**LBR-1537**  
**MEYERDING LAMINECTOMY**  
**SELF RETAINING RETRACTOR**  
 6 1/2 Inches  
 A: 41mm X 25mm  
 B: 51mm X 25mm  
 G: 57mm X 25mm



**LBR-1538**  
**WILLIAMS**  
**SELF RETAINING RETRACTOR**

- |                 |                 |
|-----------------|-----------------|
| 7 Inches LEFT:  | 7 Inches RIGHT: |
| A: 50mm X 20mm  | H: 50mm X 20mm  |
| B: 60mm X 20mm  | I: 60mm X 20mm  |
| C: 70mm X 20mm  | J: 70mm X 20mm  |
| D: 80mm X 20mm  | K: 80mm X 20mm  |
| E: 90mm X 20mm  | L: 90mm X 20mm  |
| F: 100mm X 20mm | M: 100mm X 20mm |
| G: 100mm X 20mm | N: 100mm X 20mm |



**LBR-1539**  
**JOHNSON NEUROMA**  
**SELF RETAINING RETRACTOR**

- A: 4 Inches  
 B: 5.5 Inches



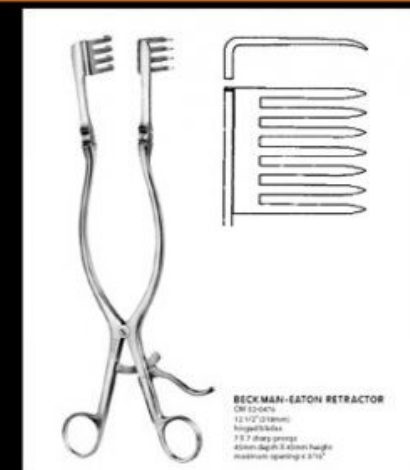
**LBR-1540**  
**CERVICAL**  
**SELF RETAINING RETRACTOR**  
 6 Inches and 10 Inches Lengths  
 A: 25mm depth  
 B: 30mm depth  
 C: 35mm depth  
 D: 40mm depth  
 E: 45mm depth  
 F: 50mm depth  
 G: 55mm depth  
 H: 60mm depth

8 Pairs of BLUNT Blades and 1 Body



**LBR-1542**  
**BECKMAN-ADSON**  
**LAMINECTOMY**  
**SELF RETAINING RETRACTOR**  
 12.25 Inches  
 Hinged Blades

- A: 4X4 Sharp 25mm X 25mm  
 B: 4X4 Sharp 44mm X 25mm  
 C: 4X4 Blunt 25mm X 25mm  
 D: 4X4 Blunt 44mm X 25mm

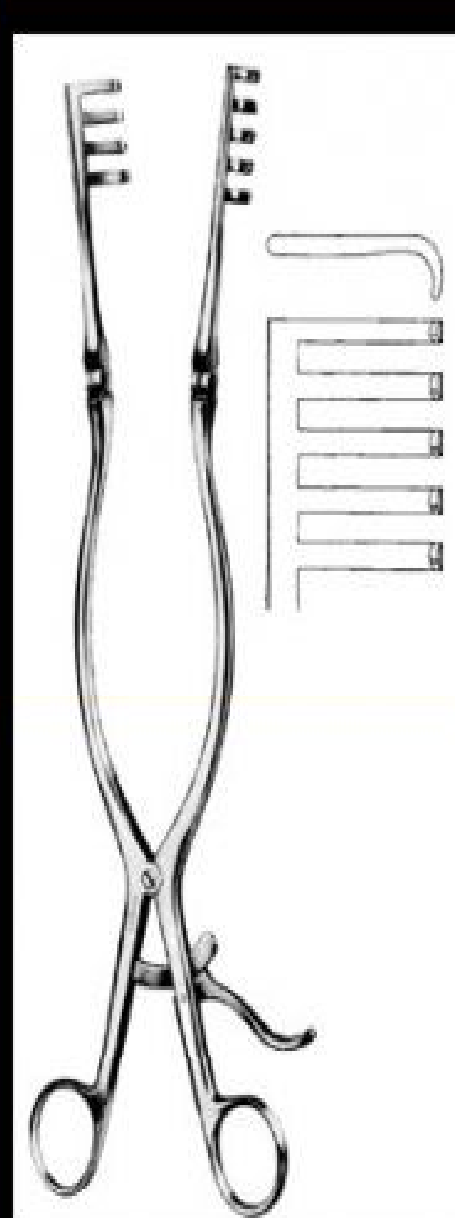


**LBR-1541**  
**BECKMAN-EATON**  
**SELF RETAINING RETRACTOR**  
 12.5 Inches Hinged Blades  
 7X7 Sharp Prongs  
 45mm X 45mm



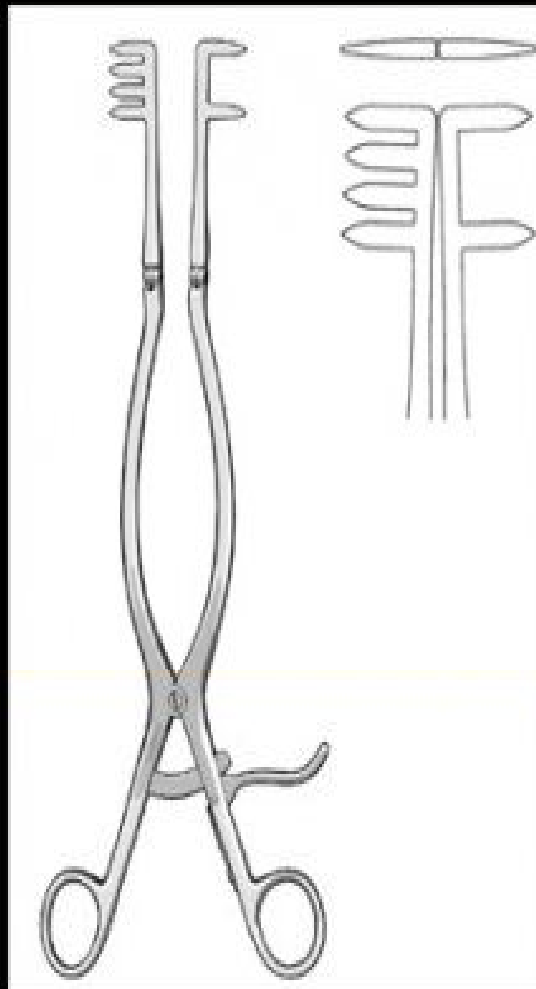
LBR-1543  
BECKMAN  
SELF RETAINING  
RETRACTOR  
12.25 Inches  
Hinged Blades

A: 4X4 Sharp 17mm X 27mm  
B: 4X4 Blunt 17mm X 27mm

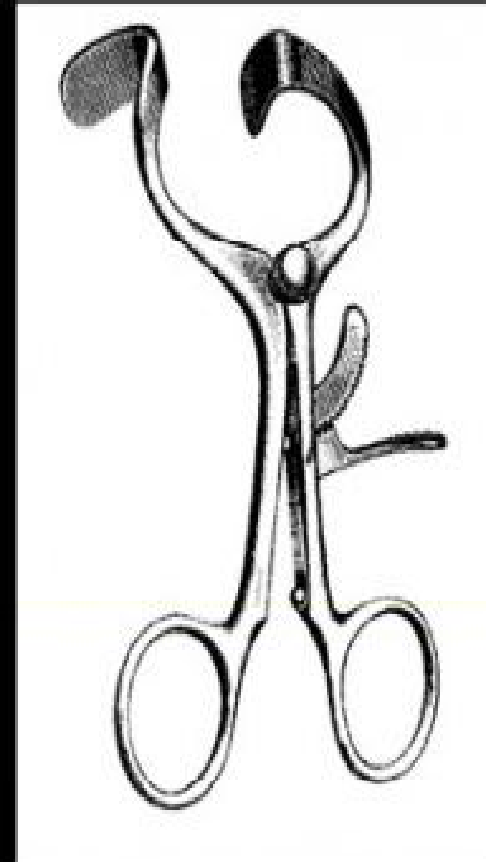


LBR-1544  
ADSON  
SELF RETAINING  
RETRACTOR  
12.50 Inches  
Hinged Blades

4X5 Blunt 25mm X 37mm



LBR-1545  
HORIZONTAL  
SELF RETAINING RETRACTOR  
12.25 Inches Hinged Blades  
4X2 Sharp 15mm X 25mm



LBR-1546  
MALTZ SEEBURGER  
SELF RETAINING RETRACTOR  
4.50 Inches



Blade Depth:  
A: 40mm  
B: 70mm  
C: 100mm

LBR-1547

KOROS SCOLIOSIS or TOTAL HIP  
SELF RETAINING RETRACTOR

11 3/4 Inches

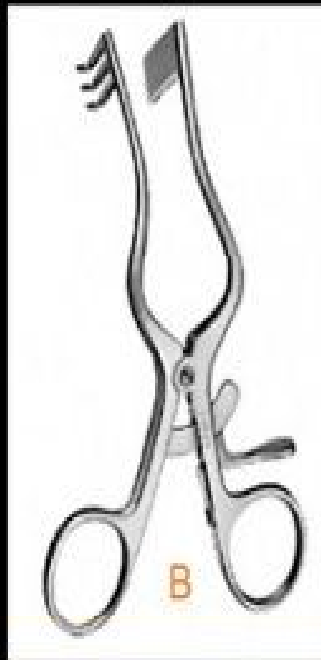
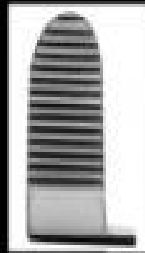
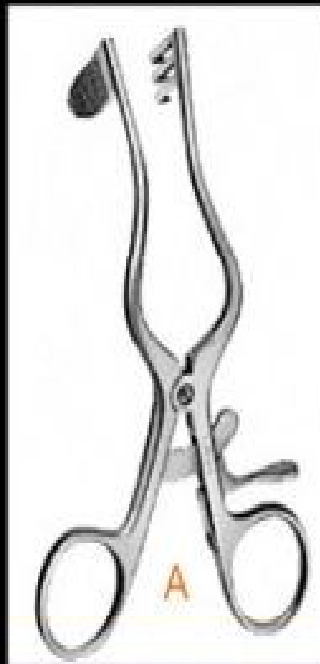


With  
5 pairs of  
Toothed and  
Non Toothed  
Blades  
40mmX15mm  
45mmX15mm  
50mmX15mm  
55mmX15mm  
60mmX15mm

LBR-1548

CLOWARD  
SELF RETAINING RETRACTOR

9 3/4 Inches

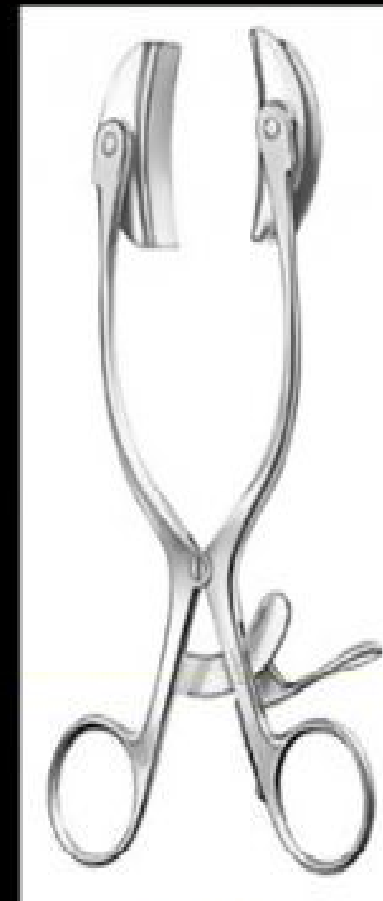


LBR-1549  
PERKINS

SELF RETAINING RETRACTOR

5 1/8 Inches

A: Right Arm 3 Sharp Prongs Left Arm Solid Blade  
B: Left Arm 3 Sharp Prongs Right Arm Solid Blade



LBR-1550

COLLIN BABY ABDOMINAL  
SELF RETAINING RETRACTOR

8 Inches

Complete with 2 Pairs of Blades  
40X18mm and 40X28mm



LBR-1551  
COLLIN  
ABDOMINAL RETRACTOR  
9.25 Inches

Complete with 1 Pair of Blades  
38X60mm



LBR-1552  
COLLIN ABDOMINAL  
RETRACTOR  
9 Inches

A: Complete with 1 Pair of Blades 38X60mm  
and Central Blade 38X55mm

B: Complete with 1 Pair of Blades 45X80mm  
and Central Blade 50X75mm



LBR-1553  
COLLIN ABDOMINAL  
SELF RETAINING  
RETRACTOR  
12 1/4 Inches

Complete with 1 Pair of Blades 60X80mm  
and Central Blade 60X75mm



LBR-1554  
RICARD ABDOMINAL  
RETRACTOR

A: 30CM Spread w/1 Pair of Blades 80x60mm  
& 1 Center Blade 70x55mm

B: 28CM Spread w/ 1 Pair of Blades 85x72mm  
& 1 Center Blade 90x80